

F-420 Flow Meter

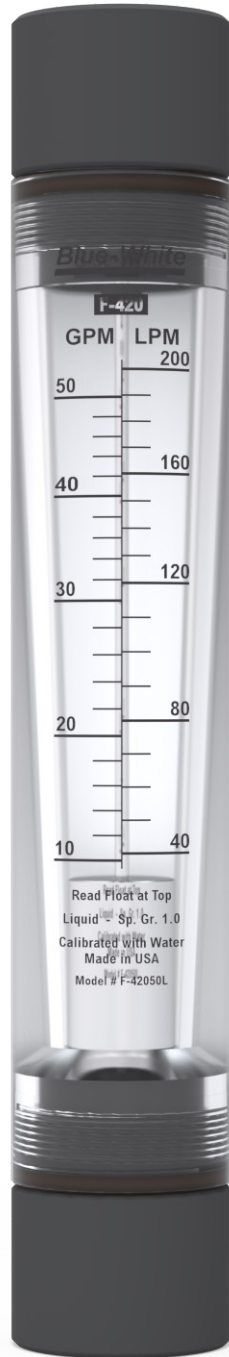

READ THE ENTIRE OPERATING MANUAL PRIOR TO INSTALLATION AND USE.



+1 (714) 893 - 8529



sales@blue-white.com



customerservice@blue-white.com





5300 Business Drive
Huntington Beach, CA 92649

Table of Contents

1.0 Introduction	5
1.1 What's in the box	5
1.2 Features	5
1.3 Application Notes	5
1.3 Ordering Information / Product Matrix	6
2.0 Engineering Specifications	6
2.1 Flow Meter Specifications	6
2.2 Materials of Construction	7
2.3 Flow vs. Pressure Graph	7
2.4 Flow Specifications	7
2.5 Dimensions	8
3.0 Installation	8
3.1 Installation Requirements	8
3.2 Tools Required	8
3.3 Installation Instructions	9
4.0 Reading your Flow Meter	9
5.0 Maintenance and Troubleshooting	10
6.0 Spare Parts	10
7.0 Warranty	11

SAFETY INFORMATION

Please read this manual completely before unpacking, installing, and operating this equipment. In particular, pay attention to all dangers, warnings, and precautions, otherwise, it may cause serious injury to the operator or damage to the equipment.

Symbol	Description
	Warning (Risk of electric shock)
	Caution (Refer to the user's guide)
	Ground, Protective Conductor Terminal

Note: When in doubt regarding your electrical installation, contact a licensed electrician.

1.0 Introduction

Congratulations on purchasing the F-420 Flow Meter!

Your Flow Meter is calibrated and ready for use. The unit is designed to give many years of service. For more information or questions on this product or any of our Industrial products, please visit us at www.blue-white.com

1.1 What's in the box

- Flow meter (1)
(Flow meter may contain plastic tubing for protection during shipping. Remove before installation.)
- Quick Start Guide

Check all packaging for completeness and inspect for damage before installation.

1.2 Features

- Dual Scale (GPM / LPM), screen printed with white backing on opposite side for easy reading
- Tested and calibrated for clean water applications
- Acceptable for outdoor installations - One piece machined acrylic meter body
- Threaded adapters make for simple install on piping
- Unique O-ring design prevents leaks
- Upward flow, vertical installation only

1.2 Application Notes

Although meters may be suitable for other chemicals, Blue-White cannot guarantee their suitability. It is the responsibility of the user to determine the suitability of the flow meter in their application. **Flow meters are tested and calibrated for water only.**

1.3 Ordering Information / Model Number Matrix

F-420 Model Number

F	Flow Meter					
Series						
	420	F-420 Acrylic Body				
Scale						
	25	5-25 gpm (20 - 100 lpm) 316ss float				
	40	8-40 gpm (30 - 150 lpm) 316ss float				
	50	10-50 gpm (40 - 200 lpm) 316ss float				
Guide-Wire Material						
	LN	316 Stainless steel rod				
Adapter						
	(Blank)	1.5" Male NPT, PVC				
	-16	1.0" Female NPT, PVC				
O-Rings						
	(Blank)	Viton				
	-22P	EP				
F	-	420	25	LN		Sample Model Number

*In-house NIST Calibration, OEM packaging and silicone oil free options are also available.

2.0 Engineering Specifications

2.1 Flow Meter Specifications

Maximum Working Pressure	130 PSI (8.9 bar) at 70 °F (21 °C)
Maximum Fluid Temperature Range	130 °F / 54 °C @ 0 PSI
Ambient Temp Range	0° to 110 °F / -18 to 43 °C
Full Scale Accuracy	+/- 5%
Calibration Fluid	Water, specific gravity 1.0
Environment	Acceptable for direct sunlight exposure
Approximate Shipping Weight	2 lb (.91kg)

2.2 Materials of Construction

Wetted Components:	
Meter Body	Cast acrylic rod, Annealed
Adapters	PVC
Guide Rod Holder	Polysulfone
O-ring Seals	Viton® (optional EP)
Float	316SS
Guide Rod	316SS

2.3 Temperature vs. Pressure Graph

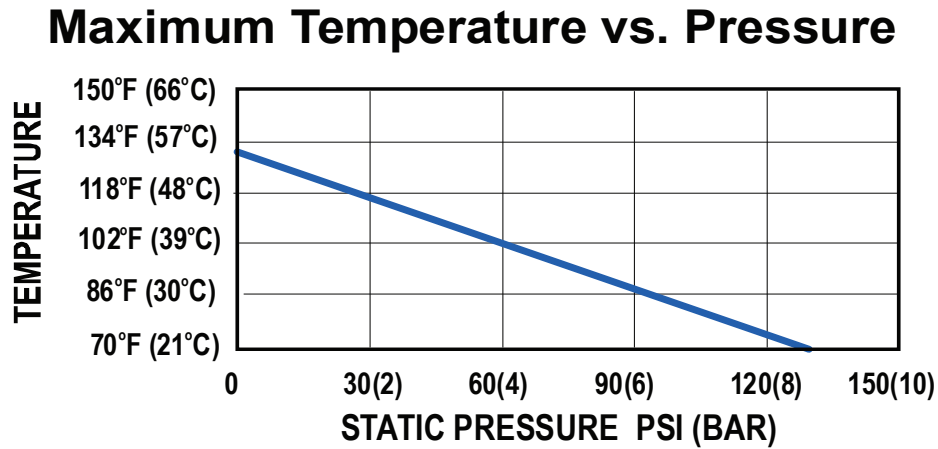

2.4 Flow Specifications

Model	Feed Rate		Max Pressure	Max Temperature	Float Material
	GPM	LPM	PSI (bar)	°F (°C)	
F-42025LN	5 - 25	20 - 100	130 (8.9)	70 (21)	316SS
F-42040LN	8 - 40	30 - 150	130 (8.9)	70 (21)	316SS
F-42050LN	10 - 50	40 - 200	130 (8.9)	70 (21)	316SS

2.5 Dimensions

Dim	Inch	cm
A	12"	30.5
B	2"	5.1

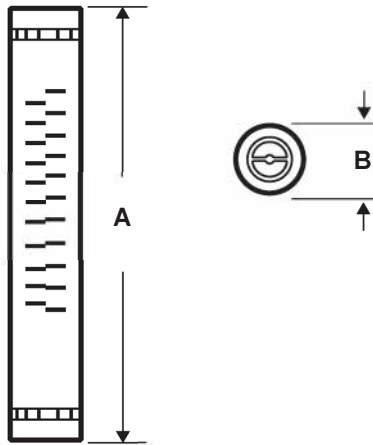

3.0 Installation

3.1 Installation Requirements

Before beginning installation, review your system flow and pressure to ensure your F-420 is proper for your system parameters.

Pipe Requirements:

- The flow meter is designed to work best when installed in a perfectly vertical pipe system.
- Ensure piping design prevents any stress on the meter fittings, minimizes vibration, and ensures location with direct visibility and minimal possibility of damage from forcible contact.
- Pipe should be clean and free of debris.
- Connecting pipe should be uniform and not warped.
- Pipe must be properly supported even during maximum water flow conditions.
- Use of unionized fittings before and after the flow meter will allow for easier installation and removal for maintenance.
- On/Off solenoid valves and pumps installed before the flow meter should be accompanied by flow regulating/throttling valves, or similar device, to prevent sudden and forcible flows through the flow meter which can cause damage to flow meter components.
- Choose location where pipe will be full at all times.

3.2 Tools Required

- PTFE Tape
- Level

Note: Keep flow meter away from pipe glue fumes. Ensure all pipe glue is dry before installation flow meter. Pipe glue solvents will damage acrylic.

Example of acrylic flow meter exposed to glue fumes / solvents. Cracking of acrylic.

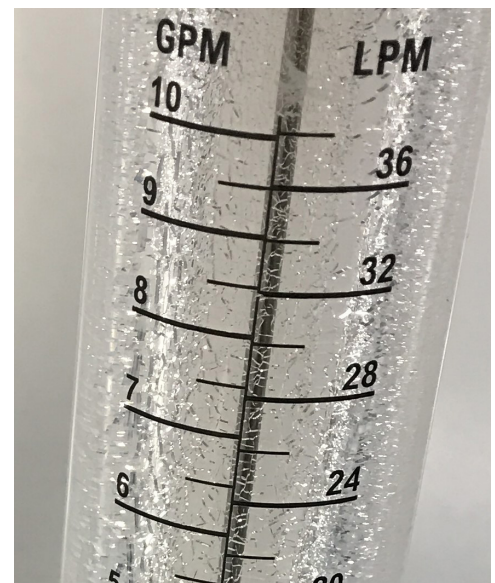



Always wear protective clothing, face shield, safety glasses and gloves when working on your equipment. Use caution when lifting and mounting equipment. When in doubt, contact factory for assistance.

3.3 Installation Instructions

1. **The flow meter must be installed in a vertical plane to ensure accuracy.** Prepare piping and components per standard piping installation.
2. **Use only PTFE tape on the threaded adapters.** Pipe dope and glue will damage the meter body and fittings. Or install the flow meter after all glued fittings have dried and fumes have been purged from the system.
3. **Mounts and supports must be sturdy enough to support the plumbing and prevent vibration.** Vibration and heavy loads will damage the meter.
4. **Avoid imposing a sudden burst of flow to the meter. Solenoid valves will damage the meter.** Such a burst will cause the float to impact the top float stop with destructive force.
5. **The Maximum fluid temperature is dependent on the working pressure.** High pressure and temperature will damage the meter. (see temperature VS pressure chart)

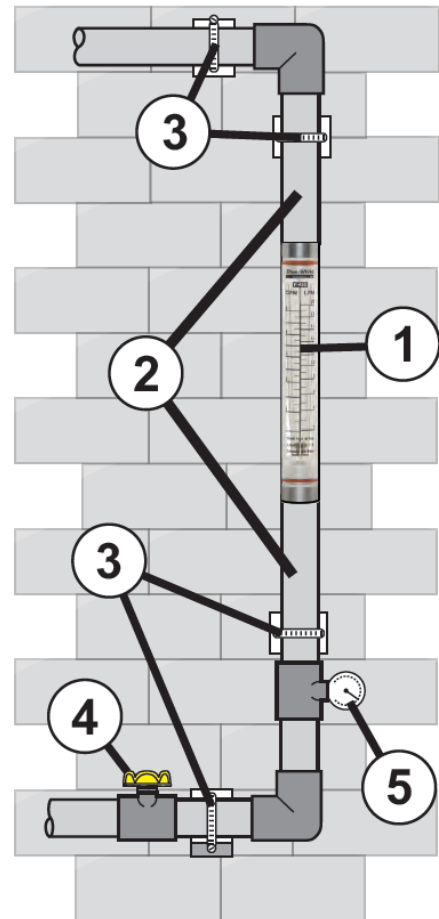

4.0 Reading your F-420 Flow Meter

Avoid imposing a sudden burst of flow to the meter. Solenoid valves may cause the float to impact the top float stop with destructive force. Always read float at top.

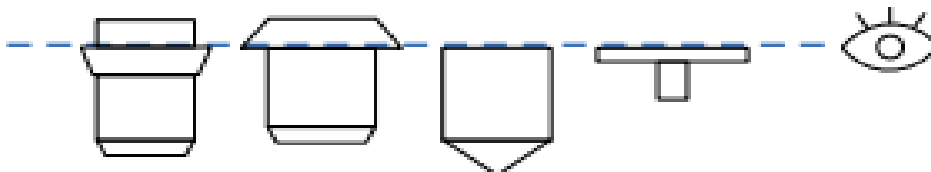

Different types of float

5.0 Maintenance and Troubleshooting

- The F-420 Flow Meter requires very little maintenance. However, the flow meter may become clogged due to excess debris in the water. If this happens, simply shut of the process pump or valve and remove any pressure from the piping. If isolation valves are installed, shut these to minimize the amount of water that may leak. Locate nearest unions on piping to allow for removal of flow meter. Remove the flow meter and clean any debris in the flow meter. Use mild soap and a soft bristle brush.
- Reinstall the flow meter and test. **If the float was removed during the cleaning process, ensure the float was reinstalled properly.** The float is wider at the top.
- If flow meter requires NIST Calibration Certification, please contact the factory for this service.

6.0 Spare Parts

Item	Model No.	Product Name	Qty. Req.
1	76001-028	1.0" FPT Adapter (PVC)	2
	76001-026	1.5" MPT Adapter (PVC)	2
2	2-127V	O-ring, 127 (Viton)	2
	90003-154	O-ring, 127 (EP)	2
3	91001-159	Wire holder (PSF)	2
4	2-006A	O-ring, 006 (Aflas)	2
	2-006EB	O-ring, 006 (EP)	2
5	-	Float (SS) (not sold separately)	1
6	F-4212	Guide Wire (SS)	1
7	-	Meterbody (not sold separately)	1

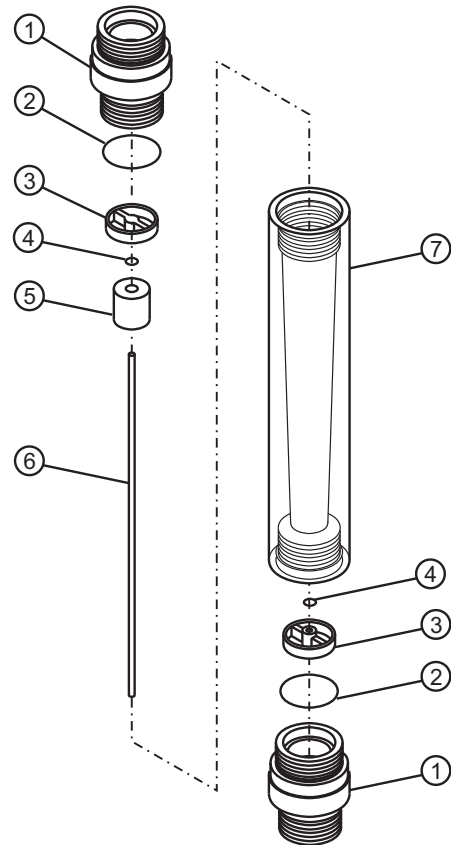

7.1 LIMITED WARRANTY

Your new Flow Meter is a quality product and is warranted for 12 months from date of purchase (proof of purchase is required). The unit will be repaired or replaced at our discretion. Failure must have occurred due to defect in material or workmanship and not as a result of operation of the product other than in normal operation as defined in the manual. Warranty status is determined by the serial label and the sales invoice or receipt. The serial label must be on the unit and legible. The warranty status of the unit will be verified by Blue-White or a factory authorized service center.

7.2 WHAT IS NOT COVERED

- Wear items.
- Unit removal, or re-installation, and any related labor charge.
- Freight to the factory, or service center.
- Units that have been tampered with, or in pieces.
- Damage to the unit that results from misuse, carelessness such as chemical spills on the enclosure, abuse, lack of maintenance, or alteration which is out of our control.
- Units damaged by faulty wiring, power surges or acts of nature.

7.3 PROCEDURE FOR IN WARRANTY REPAIR

Contact the factory to obtain a RMA (Return Material Authorization) number. Carefully pack the unit to be repaired. Please enclose a brief description of the problem as well as the original invoice or sales receipt, or copy showing the date of purchase. Prepay all shipping costs. COD shipments will not be accepted. Warranty service must be performed by the factory or an authorized service center. Damage caused by improper packaging is the responsibility of the sender. When In-Warranty repair or replacement is completed, the factory pays for return shipping to the dealer or customer.

7.4 PRODUCT USE WARNING

Blue-White products are manufactured to meet the highest quality standards in the industry. Each product instruction manual includes a description of the associated product warranty and provides the user with important safety information. Purchasers, installers, and operators of Blue-White products should take the time to inform themselves about the safe operation of these products. In addition, Customers are expected to do their own due diligence regarding which products and materials are best suited for their intended applications. Blue-White is pleased to assist in this effort but does not guarantee the suitability of any particular product for any specific application as Blue-White does not have the same degree of familiarity with the application that the customer/end user has. While Blue-White will honor all of its product warranties according to their terms and conditions, Blue-White shall only be obligated to repair or replace its defective parts or products in accordance with the associated product warranties. **BLUE-WHITE SHALL NOT BE LIABLE EITHER IN TORT OR IN CONTRACT FOR ANY LOSS OR DAMAGE WHETHER DIRECT, INDIRECT, INCIDENTAL, OR CONSEQUENTIAL, ARISING OUT OF OR RELATED TO THE FAILURE OF ANY OF ITS PARTS OR PRODUCTS OR OF THEIR NONSUITABILITY FOR A GIVEN PURPOSE OR APPLICATION.**

7.5 CHEMICAL RESISTANCE WARNING

Blue-White offers a wide variety of wetted parts. Purchasers, installers, and operators of Blue-White products must be well informed and aware of the precautions to be taken when injecting or measuring various chemicals, especially those considered to be irritants, contaminants or hazardous. Customers are expected to do their own due diligence regarding which products and materials are best suited for their applications, particularly as it may relate to the potential effects of certain chemicals on Blue-White products and the potential for adverse chemical interactions. Blue-White tests its products with water only. The chemical resistance information included in this instruction manual was supplied to Blue-White by reputable sources, but Blue-White is not able to vouch for the accuracy or completeness thereof. While Blue-White will honor all of its product warranties according to their terms and conditions, Blue-White shall only be obligated to repair or replace its defective parts or products in accordance with the associated product warranties. **BLUE-WHITE SHALL NOT BE LIABLE EITHER IN TORT OR IN CONTRACT FOR ANY LOSS OR DAMAGE, WHETHER DIRECT, INDIRECT, INCIDENTAL, OR CONSEQUENTIAL, ARISING OUT OF OR RELATED TO THE USE OF CHEMICALS IN CONNECTION WITH ANY BLUE-WHITE PRODUCTS.**

Blue-White®

Fluid metering solutions made simple

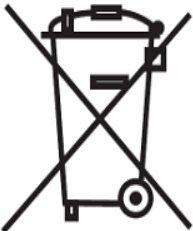

Users of electrical and electronic equipment (EEE) with the WEEE marking per Annex IV of the WEEE Directive must not dispose of end of life EEE as unsorted municipal waste, but use the collection framework available to them for the return, recycle, recovery of WEEE and minimize any potential effects of EEE on the environment and human health due to the presence of hazardous substances. The WEEE marking applies only to countries within the European Union (EU) and Norway. Appliances are labeled in accordance with European Directive 2002/96/EC.

Contact your local waste recovery agency for a *Designated Collection Facility* in your area.