	<b>AccuPro-5000™ MEASUREMENT SYSTEM OPERATOR MANUAL</b>		
Issued by Department: Engineering	Doc. Number: 5000-00-00-002	Revision: 02	Effective Date: 10/05/2021



# AccuPro-5000™

## Measurement System Operator Manual

Scaleton Industries, LTD  
53 Appletree Lane  
Plumsteadville, PA 18949

All information contained in this document is confidential to Scaleton Industries, Ltd. No license is expressed or implied, under any patent, copyright or trade secret right is granted or implied by the conveyance of this document. No part of this document may be reproduced, transmitted, transcribed, stored in a retrieval system, translated into any language or computer language, in any form or by any means, electronic, mechanical, magnetic, optical, chemical, manual, or otherwise without the prior written permission of Scaleton Industries, Ltd.

		<b>AccuPro-5000™ MEASUREMENT SYSTEM OPERATOR MANUAL</b>	
Issued by Department: <b>Engineering</b>	Doc. Number: <b>5000-00-00-002</b>	Revision: <b>02</b>	Effective Date: <b>10/05/2021</b>

## Table of Contents

1	Introduction .....	6
1.1	Scope .....	6
1.2	Acronyms and Abbreviations.....	6
1.3	Definitions.....	7
2	System Specification Summary .....	8
3	Assembly and Set-Up Instructions .....	11
3.1	Factory Configuration.....	12
3.2	Control-Panel Preparation and Mounting.....	12
3.3	External Connections.....	13
4	System Hardware .....	14
4.1	Liquid Crystal Display (LCD) Board.....	14
4.2	Backplane Board.....	15
4.3	Main Processor Board.....	17
4.4	Analog Input Board.....	19
4.5	Analog Output Board (4-20 mA Output).....	20
4.6	Analog Output Board (0-5V/10V Output) .....	22
4.7	Relay Output Board (Dual or Quad Relays) .....	24
5	User Controls .....	25
5.1	Keypad .....	26
5.2	Rotary Knob .....	26
6	User Indicators .....	26
6.1	LCD Module .....	26
6.2	Channel Status LED Array .....	26
7	System Modes .....	28
7.1	Run Mode .....	28
7.2	Setup Mode .....	28
8	System Main Menu .....	29
8.1	Scale Display .....	32
8.2	Alerts/Alarms .....	32
8.3	Dead Weight.....	35



# AccuPro-5000™ MEASUREMENT SYSTEM OPERATOR MANUAL

Issued by Department: Engineering	Doc. Number: 5000-00-00-002	Revision: 02	Effective Date: 10/05/2021
--------------------------------------	--------------------------------	-----------------	-------------------------------

- 8.4 Calibrate Weight..... 37
- 8.5 Capacity Weight..... 39
- 8.6 System Config ..... 40
- 8.7 Channel Config ..... 43
- 8.8 Liquid Mass..... 45
- 8.9 Tare Adjust / Tare Secured ..... 47
- 8.10 Relay Setpoint..... 49
- 8.11 mA/V Output ..... 52
- 8.12 Real-Time Clock ..... 54
- 8.13 About..... 57
- 9 Maintenance..... 59
  - 9.1 Cleaning ..... 59
  - 9.2 Servicing the Control-Panel ..... 59
  - 9.3 Removing/Installing a Printed Circuit Board ..... 59
  - 9.4 Removing/Installing PCB Wire Connections ..... 60
- 10 Troubleshooting ..... 60
  - 10.1 The Control-Panel is Not Receiving Power..... 60
  - 10.2 The Measurement Value is Blinking..... 61
  - 10.3 The 4-to-20 mA Reading is Incorrect..... 61
  - 10.4 A Relay Output is Not Responding Correctly ..... 62
  - 10.5 Tare Weight Drift ..... 62
- 11 Revision Log..... 63



# AccuPro-5000™ MEASUREMENT SYSTEM OPERATOR MANUAL

Issued by Department:  
Engineering

Doc. Number:  
5000-00-00-002

Revision:  
02

Effective Date:  
10/05/2021

Figure 1: LCD Board (Bottom Side).....	14
Figure 2: Backplane Board.....	16
Figure 3: Main Processor Board.....	18
Figure 4: Analog Input Board.....	20
Figure 5: Multiple Current AOBs with Shared Loop Power Supply.....	21
Figure 6: Analog Output Board - mA.....	22
Figure 7: Analog Output Board - V.....	23
Figure 8: Relay Output Board.....	24
Figure 9: Control-Panel Overlay (Keypad Version).....	25
Figure 10: System Menu Displays.....	29
Figure 11: Action Canceled Display.....	30
Figure 12: SCALE DISPLAY Menu Option.....	32
Figure 13: Single versus Dual-Channel Measurement Display.....	32
Figure 14: ALERTS/ALARMS Menu Option.....	33
Figure 15: ALERTS / ALARMS Messages.....	34
Figure 16: DEAD WEIGHT Menu Option.....	35
Figure 17: DEAD WEIGHT Control Flow Diagram.....	36
Figure 18: CALIBRATE WEIGHT Menu Option.....	37
Figure 19: CALIBRATE WEIGHT Control Flow Diagram.....	38
Figure 20: CAPACITY WEIGHT Menu Option.....	39
Figure 21: CAPACITY WEIGHT Control Flow Diagram.....	40
Figure 22: SYSTEM CONFIGURATION Menu Option.....	41
Figure 23: SYSTEM CONFIGURATION Control Flow Diagram.....	42
Figure 24: CHANNEL CONFIGURATION Menu Option.....	43
Figure 25: CHANNEL CONFIGURATION Control Flow Diagram.....	44
Figure 26: Bar-Graph Display.....	45
Figure 27: LIQUID MASS Menu Option.....	46
Figure 28: LIQUID MASS Control Flow Diagram.....	47
Figure 29: TARE ADJUST & TARE SECURED Menu Option.....	48
Figure 30: TARE ADJUST Control Flow Diagram.....	48
Figure 31: TARE SECURED Control Flow Diagram.....	49
Figure 32: RELAY SETPOINT Menu Option.....	50
Figure 33: RELAY SETPOINT Control Flow Diagram.....	51
Figure 34: mA/V OUTPUT Menu Option.....	52
Figure 35: mA/V OUTPUT Control Flow Diagram.....	53
Figure 36: REALTIME CLOCK Menu Option.....	55
Figure 37: Setting the Time/Date Control Flow Diagram.....	56
Figure 38: ABOUT Menu Option.....	57
Figure 39: ABOUT Control Flow Diagram.....	58



# AccuPro-5000™ MEASUREMENT SYSTEM OPERATOR MANUAL

Issued by Department: Engineering	Doc. Number: 5000-00-00-002	Revision: 02	Effective Date: 10/05/2021
--------------------------------------	--------------------------------	-----------------	-------------------------------

Table 1: External Alarm Interface .....	17
Table 2: System Mode Controls .....	17
Table 3: Load-Cell Interface .....	19
Table 4: Leak-Detect Sensor Interface .....	19
Table 5: Current Loop Interface .....	21
Table 6: Voltage Output Interface .....	23
Table 7: Relay Interface .....	24
Table 8: Alerts/Alarms Priority Levels .....	27
Table 9: Operational Menu Tree .....	31

## 1 Introduction

The AccuPro-5000™ is a weight and volume measurement system offering single/dual-channel support. Its real-time measurement indication allows for precise monitoring during the process of filling or emptying a chemical substance container.

### 1.1 Scope

This document describes the specifications, installation, capabilities, and basic operation of the Control-Panel portion of the AccuPro-5000™ Measurement System. The Control-Panel represents the common component used in multiple Measurement System configurations, differing mainly in the selection of a Scale-Base. Detailed information for the Scale-Base is available in a separate document.

### 1.2 Acronyms and Abbreviations

- **AC** Alternating Current (reference to power-supply type)
- **ADC** Analog to Digital Converter
- **AIB** Analog Input Board
- **AOB** Analog Output Board (either mA or V)
- **AWG** American Wire Gauge
- **DAC** Digital to Analog Converter
- **DC** Direct Current (reference to power-supply type)
- **DCS** Distributed Control System
- **EEPROM** Electrically Erasable Programmable Read Only Memory
- **HMI** Human-Machine Interface (Controls, Indicators, and Display Menus)
- **ICE** In-Circuit Emulator (A device programmer/debugging tool)
- **LCD** Liquid Crystal Display
- **LED** Light-Emitting Diode
- **MPB** Main Processor Board
- **N/A** Not Applicable
- **NC** Normally Closed (contacts)
- **NO** Normally Open (contacts)
- **PCB** Printed Circuit Board
- **PLC** Programmable Logic Controller
- **POR** Power-On Reset
- **ROB** Relay Output Board
- **RTC** Real Time Clock (MCP795W10 device on MPB)
- **RU SURE** Short for “Are You Sure?” prompt
- **SCADA** Supervisory Control And Data Acquisition
- **SPDT** Single-Pole, Double-Throw (Effective relay switch configuration)
- **SRAM** Static Random-Access Memory

		<b>AccuPro-5000™ MEASUREMENT SYSTEM OPERATOR MANUAL</b>	
Issued by Department: Engineering	Doc. Number: 5000-00-00-002	Revision: 02	Effective Date: 10/05/2021

## 1.3 Definitions

- **Assert:** A term that describes the activation, triggering, or turning-ON of a device, indicator, or machine state.
- **Channel:** A term synonymous with “Scale” in this context, a configuration of circuit boards consisting of an Analog Input Board (required) and optional Analog Output Board and/or Relay Output Board. Together, the boards enable the real-time weight and/or volume measurement of material placed on a Scale-Base, then produce proportional output signals of the measurement by way of an analog current (4-20 mA) or voltage (0-10 V) output signal. High-voltage relay switch openings and closures can also be activated at predefined measurement setpoints for interfacing to a user’s external circuitry.
- **Control-Panel:** The component of an AccuPro-5000™ Measurement System that houses the electronics that support the Human-Machine Interface (HMI.) All wiring connections for scales, sensors, alarms, and SCADA will terminate in the Control-Panel.
- **ENTER:** The act of selecting a given menu option or numeric entry as presented on the display by way of pressing either the Enter Key or the Rotary Knob switch.
- **Jumper-Shunt:** A 2-position shorting pin placed on a jumper-field used to configure hardware.
- **Keypad:** An optional Control-Panel overlay having embedded dome-style, push-button membrane switches used to navigate and operate the AccuPro-5000™ menus.
- **Main Menu:** A collection of high-level, user-control categories from which a user can access one or more submenu control options for system calibration, configuration, and data entry.
- **Measurement System:** A term that describes a complete AccuPro-5000™ Measurement System consisting of the Control-Panel and Scale-Base components.
- **Negate:** A term that describes the de-activation, or turning-OFF, of a device, indicator, or machine state.
- **Rotary Knob:** An optional rotary control device that generates a sequence of directionally-coded pulses at a rate that is proportional to its rotational speed. The generated pulses are interpreted as assertions of either the Down (CCW) or Up (CW) Arrow keys. In addition, pressing the knob causes a switch-closure that is used to “Enter” a menu selection or numerical value.
- **Scale-Base:** The component of an AccuPro-5000™ system that houses the load-cell sensor(s) and platform onto which the material being measured is placed.
- **Setpoint:** A user-defined scale measurement value, or threshold, that corresponds to a predefined condition or event, such as the 4 mA and 20 mA output points of the Analog Output Board. A setpoint may also be used to indicate an Alert/Alarm condition via assertion of the Relay Output Board as a means to inform a user or SCADA system that some event has occurred or some action is needed.
- **Submenu:** A low-level, HMI environment that is part of a main menu category within which system calibration, configuration, or data entry actions are performed.
- **Tare:** A measurement allowance intended to offset the physical means of containing or packaging a chemical substance so as to determine the net weight of goods.



## AccuPro-5000™ MEASUREMENT SYSTEM OPERATOR MANUAL

Issued by Department:  
Engineering

Doc. Number:  
5000-00-00-002

Revision:  
02

Effective Date:  
10/05/2021

## 2 System Specification Summary

System	
Main Power	<p>120/240 VAC +/- 10%, 50/60-Hz</p> <p><u>Wattage:</u> 74.7 W (maximum) @ 83% Efficiency</p> <p><u>Fuse:</u> 1.0A @ 120 VAC / 0.5A @ 240 VAC (5x20 mm, type slow-blow)</p> <p><u>Connector:</u> Sealed</p>
DC Regulated Power	<p><u>Triple-Output:</u> 5 VDC @ 4 A / +12 VDC @ 3 A / -12 VDC @ 0.5 A</p>
Operational Temperature	<p>0° C to 60° C (32° F to 140° F)</p>
Operational Altitude	<p>2000 meters (maximum)</p>
Operational Relative Humidity	<p>20% to 90% non-condensing</p>
Enclosure (Control-Panel)	<p><u>Nominal Size:</u> 8 x 8 x 4 Inches (LxWxD) with hinged cover</p> <p><u>Weight:</u> 6 lbs. (approx. maximum)</p> <p><u>Material:</u> Opaque Polycarbonate, UL Listed Type 4X NEMA</p> <p><u>Location Recommendation:</u> The Control-Panel should be operated in a location that protects it from being soaked with liquids or exposed to extreme weather conditions. If the system is to be located outdoors, you must make sure not to exceed the operational temperature range. It is further recommended that a covering be used to protect the indicator from the elements. Locations inside buildings should be at a height that protects it from chemical splashes and wash-down areas, but still allow for easy operation of the Control-Panel.</p>
Channels	<p>Supports single or dual-channel configurations. Each channel is independently controlled and operated.</p>





## AccuPro-5000™ MEASUREMENT SYSTEM OPERATOR MANUAL

Issued by Department: Engineering	Doc. Number: 5000-00-00-002	Revision: 02	Effective Date: 10/05/2021
--------------------------------------	--------------------------------	-----------------	-------------------------------

Measurement	<p><b>Range:</b> Up to (6) Digits. (5) Integer / (1) Fraction (user-selectable)</p> <p><b>Working Capacity:</b> Determined, in part, by factory limits and Scale-Base specifications. Reference Scale-Base documentation.</p> <p><b>Units:</b> User-selectable units of Pound, Kilogram, Gallon, or Liter. Units of volume require user-entry of chemical substance's density or specific gravity value.</p> <p><b>Averaging:</b> User-selectable smoothing filter of 10, 20, 50, or 100 samples/average.</p> <p><b>Bar-graph:</b> User-selectable graphical display showing relative tare, net measurement, and system capacity components. With bar-graph enabled, measurement display may be limited to a single channel.</p> <p><b>Performance:</b> Overall system accuracy is 0.1% to 0.25% Full Scale.</p>
Liquid Crystal Display	<p><b>Size:</b> 16-Characters x 2-Row, supports simultaneous measurement display of (2) channels.</p> <p><b>Backlighting:</b> 16 user-adjustable LED brightness levels (via menu)</p> <p><b>Contrast:</b> User-adjustable (via potentiometer on LCD Board)</p>
Indicators	<p>(2) bi-color LED status indicators, (1) for each channel. Each indicator yields up to four prioritized states as described herein.</p>
Alarms	<p><b>Internal:</b> Audible buzzer, 3.4 kHz, 78 dB (max)</p> <p><b>External:</b> Support for a user-supplied, external alarm/indicator by way of a switching relay offering a SPDT contact configuration (NO-COM-NC). Switching capacity of 3A @ 250 VAC or 30 VDC resistive. Inductive loads not recommended.</p>
Controls	<p><b>Options:</b></p> <ul style="list-style-type: none"> <li>• (3) key membrane panel: Down-Arrow, Enter, Up-Arrow             <ul style="list-style-type: none"> <li>○ Press-&amp;Hold Arrow keys for (2) seconds to initiate a fine auto-repeat function; hold an additional (8) seconds to initiate a coarse repeat function.</li> </ul> </li> <li>• Optical rotary encoder knob with context-sensitive speed response             <ul style="list-style-type: none"> <li>○ CCW rotation substitutes for a Down-Arrow key-press</li> <li>○ CW rotation substitutes for an Up-Arrow key-press</li> <li>○ Push-button switch substitutes for an Enter key-press</li> </ul> </li> </ul>



## AccuPro-5000™ MEASUREMENT SYSTEM OPERATOR MANUAL

Issued by Department:  
Engineering

Doc. Number:  
5000-00-00-002

Revision:  
02

Effective Date:  
10/05/2021

### Analog Input Board

Load Cells	Supports up to (4) 350-Ohm load cells producing a net 87.5 Ohm load.
Excitation Voltage	+7.5 V @ 150 mA (max)
Sensors	Leak Detect: Active-Low, logic-level input (includes 5V supply)

### Analog Output Board - mA

Loop Power	<u>Options:</u> (Selected via on-board jumper) <ul style="list-style-type: none"><li>• Internal supply: 24 VDC, 1500 VDC isolation</li><li>• External supply: Range 12-30 VDC</li></ul>
Loop Current	<u>Range:</u> 3.5 mA to 20.5 mA (28 mA maximum for 2 minutes) <u>Resolution:</u> < 0.001 mA
Configuration Options	<u>Programmable Setpoints:</u> User-defined, net-measurement thresholds that define the loop's 4 mA and 20 mA output positions. The output current follows a linear interpolation for all measurements that lie between the two Setpoints.

### Analog Output Board - V

Voltage Output	<u>Range:</u> (Selected via on-board jumper) <ul style="list-style-type: none"><li>• 0 VDC to 5 VDC, 1500 VDC isolation</li><li>• 0 VDC to 10 VDC, 1500 VDC isolation</li></ul> <u>Resolution:</u> < 0.0001 mV (0-5 V Range), < 0.0002 mV (0-10 V Range)
Load Resistance	2000 Ohm (nominal)
Configuration Options	<u>Programmable Setpoints:</u> User-defined, net-measurement thresholds that define the output's lower and upper voltage limits. The output voltage follows a linear interpolation for all measurements that lie between the two Setpoints.



## AccuPro-5000™ MEASUREMENT SYSTEM OPERATOR MANUAL

Issued by Department:  
Engineering

Doc. Number:  
5000-00-00-002

Revision:  
02

Effective Date:  
10/05/2021

### Relay Output Board

Relay Count	Dual-Configuration: (2) Quad-Configuration: (4)
Contact Configuration	Configuration: Single-Pole, Double-Throw Contacts: Normally-Open (NO), Common, Normally-Closed (NC)
Switching Capacity	3A @ 250 VAC or 30 VDC Resistive / 1 A Pilot Duty NOTE: Inductive loads are not recommended.
Configuration Options	<p>Enable/Disable: If enabled, the selected relay's switching state will respond to defined parameters. If disabled, the relay will remain in the negated (de-energized) state.</p> <p>Units: Selectable Setpoint units of Pound (lb), Kilogram (kg), Gallon (gal), or Liter (L).</p> <p>Programmable Setpoints: User-defined, net-measurement thresholds that will trigger relay switching.</p> <p>Low or High: Defines whether relay assertion will occur in the net-measurement region below (Low) or above (High) the programmable Setpoint value.</p> <p>Free-Run or Latch: Defines whether assertion of the selected relay will continuously track the current net-measurement (Free-Run), or if an assertion state will remain latched once asserted, regardless of current net-measurement, until the user resets its state (Latch).</p> <p>Trigger Alarm: Defines whether assertion of the selected relay will assert the system alarm state.</p>

## 3 Assembly and Set-Up Instructions

Carefully read this entire section and the section titled *System Hardware* to familiarize yourself with all of the system components before making permanent changes to the Control-Panel enclosure. Attention should be given to known requirements as well as the future possibility of upgrading a single-channel configuration into a dual-channel measurement system if applicable.

		<b>AccuPro-5000™ MEASUREMENT SYSTEM OPERATOR MANUAL</b>	
Issued by Department: Engineering	Doc. Number: 5000-00-00-002	Revision: 02	Effective Date: 10/05/2021

**IMPORTANT:** *It is imperative that you read the instructions in this manual. The Control-Panel is fully tested and programmed to the corresponding Scale-Base at the factory. If you experience a problem with this equipment, please disconnect all accessories to this equipment to isolate the problem. Scaleton has taken great care to be sure the equipment is fully functional within factory specifications before it leaves our facility. It is best to familiarize yourself with this manual for set-up and operation procedures before you begin using this equipment. All safety precautions need to be observed for its safe operation. Failure to operate this equipment as instructed can result in damage to the equipment, and can possibly cause injury. Damage caused to equipment due to improper operation will not be considered for warranty coverage.*

### 3.1 Factory Configuration

Before you begin, please notice the configuration sheet that is supplied with this manual. The sheet lists the factory-programmed parameters for the AccuPro-5000™ based on ordering information. If there is a need to change any parameters, please reference this manual for options and instructions on how to proceed. Both system and channel-level configuration menus must be properly set for correct operation. Any changes in the measurement units, number of decimal places, value averaging, setpoints, and calibration will affect the measurement performance and system output! Please record any configuration changes made before contacting customer assistance for technical help.

### 3.2 Control-Panel Preparation and Mounting

The Control-Panel is shipped with a factory-installed power cord which utilizes a liquid-tight fitting. Do not modify nor restrict the ability to disconnect the power cord from an outlet. All other user connections to the Control-Panel must be made in the field per specific needs.

With power to the Control-Panel OFF, access its interior by following the procedure described in section titled *Servicing the Control-Panel*. Take time to identify the optimal location for all additional fittings or conduit. Be careful when drilling holes to avoid any damage to internal components or cabling. All drilled holes MUST be sealed to prevent both liquids and gasses from penetrating the enclosure and damaging the electronics. Avoid using fittings that do not provide a tight seal. It is recommended that all fittings be liquid-tight and 4X NEMA rated. If there is a gap or opening in the enclosure’s wall that isn’t sealed by the connector design, use a silicon caulk to seal the opening and eliminate exposure.

The Control-Panel is intended to be mounted to a wall using the four holes in the corner flanges of the enclosure. It should be mounted at operational level and away from the floor. Though the enclosure is 4X NEMA rated, it is not designed to withstand wash-down procedures nor chemical contact beyond accidental exposure. Avoid direct contact with chemicals or regular soaking of water as it may cause substantial damage to the electronics. Any damage resulting from non-adherence to these requirements will not be considered for warranty repair.

		<b>AccuPro-5000™ MEASUREMENT SYSTEM OPERATOR MANUAL</b>	
Issued by Department: Engineering	Doc. Number: 5000-00-00-002	Revision: 02	Effective Date: 10/05/2021

### 3.3 External Connections

Before attaching external wires to the Control-Panel connectors, it is recommended that the Control-Panel first be connected to a power source to confirm normal operation. If it is functioning properly, the display should briefly indicate “**Scaletron Industries**” followed by data for either one or two active channels, depending on system configuration, having random (floating input) measurement values in the selected units.

**IMPORTANT:** *Be sure to disconnect power to the Control-Panel before making any wiring connections. In addition, anti-static precautions must be followed whenever accessing the Control-Panel’s interior electronics else permanent damage may result.*

Reference section titled *Maintenance* for the proper procedure for removing a PCB and making external wire connections. With reference to the Backplane Board’s layout as depicted in Figure 2, identify the slot locations for the two supported channels and carefully remove the Analog Input Board (AIB) for the desired channel. All Scale-Base signals, with the exception of any cable shield wire, will connect to this board. Refer to the instruction manual of your Scale-Base to determine the correct connection to the Load-Cell and Leak-Detect Sensor Interface terminal blocks. When all wires are connected, re-insert the PCB following the procedure previously referenced. Connect all cable shield wires to the threaded-hole locations provided on the top of the power-supply bracket.

If applicable, carefully remove the Analog Output Board (AOB-mA) for the desired channel. Connect appropriate wires to the Current Loop Interface terminal block. Next, position the board’s slider-switch to select the correct configuration for the loop’s power source. Observe all warnings as outlined in section titled *Analog Output Board (4-20 mA Output)*. When finished, carefully re-insert the PCB following the procedure previously referenced.

If applicable, carefully remove the Analog Output Board (AOB-V) for the desired channel. Connect appropriate wires to the Voltage Out Interface terminal block. Next, configure the board’s voltage output range by either installing or removing jumper-shunts. Observe all warnings as outlined in section titled *Analog Output Board (0-5V/10V Output)*. When finished, carefully re-insert the PCB following the procedure previously referenced.

If applicable, carefully remove the Relay Output Board (ROB) for the desired channel. Connect wires to the appropriate Relay Interface terminal block as outlined in section titled *Relay Output Board (Dual or Quad Relays)*. When finished, re-insert the PCB following the procedure previously referenced.

The AccuPro-5000™ supports the attachment of a user-supplied, external indicator or audible alarm that would be triggered whenever the system detects an alarm condition as defined in section titled *Channel Status LED Array*. This feature allows for the notification of events that require attention from a remote location away from the Control-Panel. Carefully remove the Main Processor Board and connect external wires to the External Alarm Interface terminal block as outlined in section titled *Main Processor Board*. When finished, re-insert the PCB following the procedure previously referenced.

		<b>AccuPro-5000™ MEASUREMENT SYSTEM OPERATOR MANUAL</b>	
Issued by Department: <b>Engineering</b>	Doc. Number: <b>5000-00-00-002</b>	Revision: <b>02</b>	Effective Date: <b>10/05/2021</b>

When all external wire connections are complete, close the panel’s door, secure its latch, and re-install the four screws (optional.)

## 4 System Hardware

The AccuPro-5000™ hardware has been designed for modularity of function. This concept enables each channel to be configured more efficiently through selection of optional circuit boards – all interconnected via a common backplane. Upon power-up, the system scans the configuration of circuit boards and presents a tailored suite of HMI control menus to the user.

System power is provided via a high-efficiency, triple-output, AC-to-DC supply that features short-circuit protection.

### 4.1 Liquid Crystal Display (LCD) Board

With reference to Figure 1, the LCD Board manages the HMI controls and indicators. The on-board AVR processor continuously scans the control panel for Keypad switch closures and/or Rotary Knob rotation which the software first debounces for mechanical noise. These “control events” are buffered before being communicated to the Main Processor Board via a polling algorithm. An LCD Module and Status LED Array provide real-time, visual notification of system operation. Up to 8 channels can be supported with an option to configure the board for a dual-channel application.

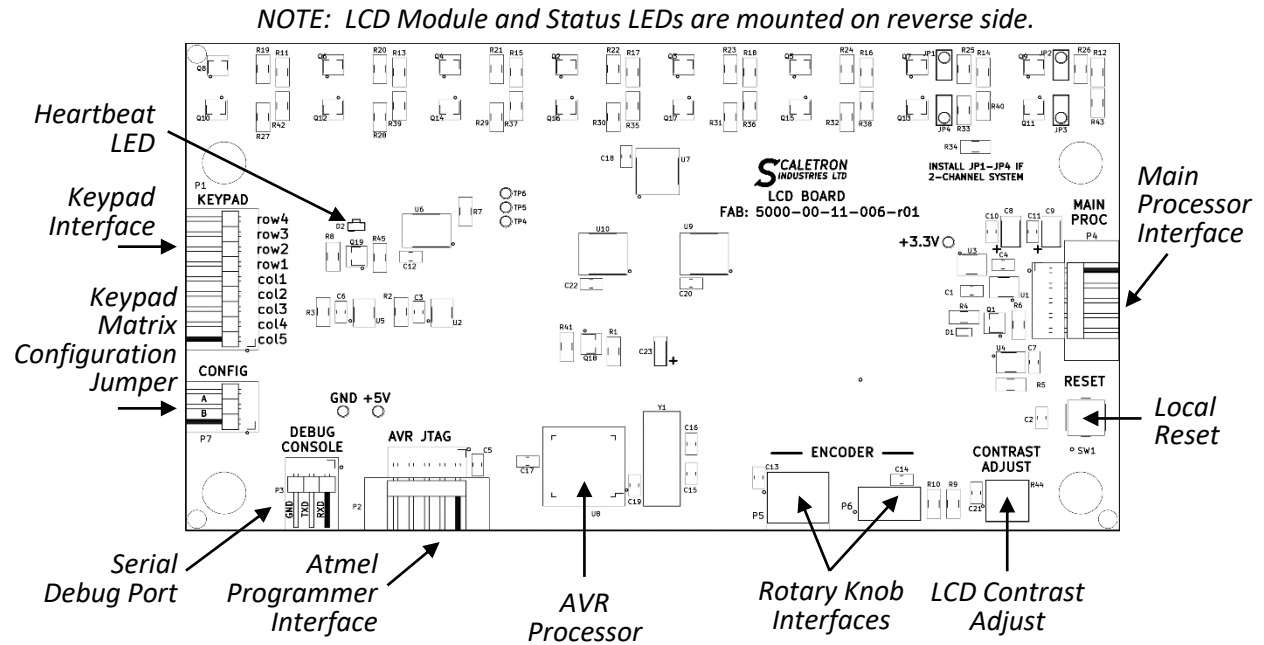



Figure 1: LCD Board (Bottom Side)

		<b>AccuPro-5000™ MEASUREMENT SYSTEM OPERATOR MANUAL</b>	
Issued by Department: Engineering	Doc. Number: 5000-00-00-002	Revision: 02	Effective Date: 10/05/2021

#### 4.1.1 Features:

- **AVR Processor:** An Atmel microprocessor that includes internal SRAM and Flash Memory.
- **Main Processor Board Interface:** The LCD Board communicates with the Main Processor Board via a full-duplex, RS-232 comm link. The LCD Board sends user-control events such as Keypad presses and Rotary Knob movement to the Main Processor Board, while the Main Processor Board sends messages to the LCD Board for display.
- **Programmer (JTAG) Interface:** The AVR processor is programmed via an Atmel ICE. Model # ATATMEL-ICE, A09-2140/08.
- **Keypad Interface:** A custom 9-pin connection to the membrane switch overlay consisting of 4 row and 5 column traces for supporting up to 20 push-buttons.
- **Keypad Matrix Configuration Jumper:** A 3-pin jumper field that the AVR processor reads to determine the configuration of the membrane switch overlay. With no jumper-shunt installed, the configuration defaults to a 1-row x 3-column switch matrix. Other configurations remain undefined at the time of this printing.
- **Serial Debug Port:** This port is for factory use only.
- **Rotary Knob Interface(s):** Supports an optional rotary control used for menu navigation and data entry.
- **Local Reset:** Pressing this button resets the AVR Processor.
- **LCD Module:** An alpha-numeric, 2-row by 16-character, monochrome Liquid Crystal Display (LCD). Limited graphic capability is also supported.
- **Status LED Array:** A bi-color LED (producing 4 states); one LED for each supported channel.
- **LCD Contrast Adjust:** A single-turn, analog potentiometer for adjusting contrast of the LCD Module.
- **Heartbeat LED:** An interior LED whose state is toggled via software at approximately 0.5Hz as a high-level indicator that the microprocessor code is executing normally. If this LED ever stops blinking, a power-cycle may be required to recover.

## 4.2 Backplane Board

With reference to Figure 2, the Backplane Board provides a platform into which other circuit boards are inserted for distribution of power and interconnection of shared signals. Inserted boards include a Main Processor Board and support for up to two measurement channels. Each channel consists of an Analog Input Board (required), an Analog Output Board (optional), and a Relay Output Board (optional). Designated connectors are assigned for each board type which utilize locking card-guides to ensure a secure fit.



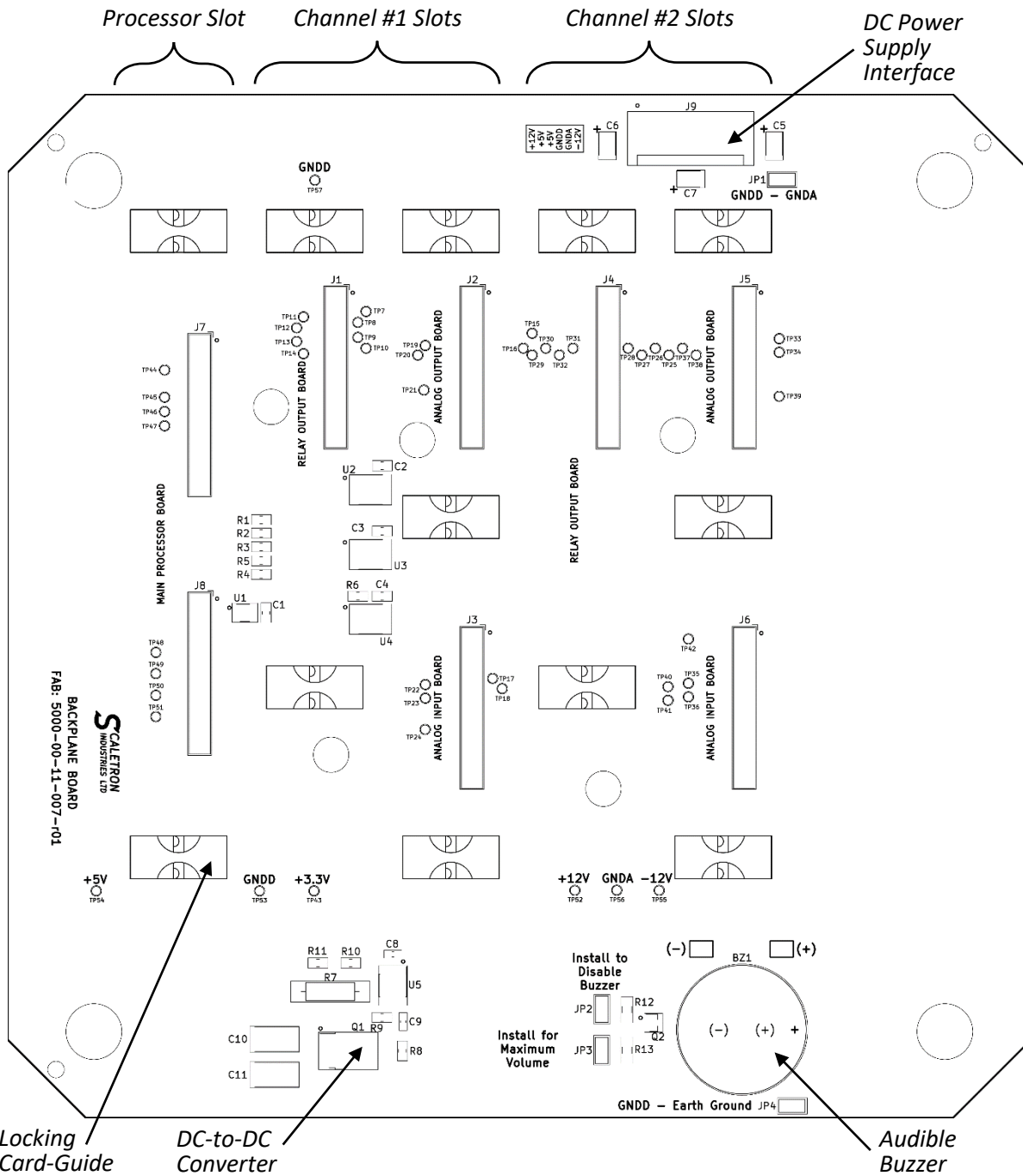



Figure 2: Backplane Board



		<b>AccuPro-5000™ MEASUREMENT SYSTEM OPERATOR MANUAL</b>	
Issued by Department: Engineering	Doc. Number: 5000-00-00-002	Revision: 02	Effective Date: 10/05/2021

#### 4.2.1 Features:

- Dual Channel Support:** The Backplane includes labeled card slots for the Main Processor Board and two complete channels consisting of an Analog Input Board and optional Analog Output Board and/or Relay Output Board. Unique PCB dimensions and connector placement prevent accidental insertion into a wrong card slot.
- Locking Card-Guides:** Card-guides serve to maintain circuit-board alignment during insertion. Once fully inserted, the circuit boards are secured by sliding a locking mechanism (red/silver pin) located on each card-guide into the notched areas of each board. Reference section titled *Removing/Installing a Printed Circuit Board* for detailed instructions.
- DC Power-Supply Interface:** Receives DC power from a triple-output power-supply module. These voltages may be further regulated prior to being distributed through the backplane to other boards.
- DC-to-DC Converter:** +5 VDC to +3 VDC regulator for low-voltage logic supply.
- Audible Buzzer:** A piezo device used to signal keypress events and/or alarm conditions. Jumper fields are available to disable the buzzer function or to select maximum volume.

### 4.3 Main Processor Board

With reference to Figure 3, the Main Process Board utilizes a SAM processor that executes the primary system code. It is responsible for interpreting user-control activity and updating all menus and messages to the LCD Board.

The board includes a terminal-block connector for attaching an external alarm (optional). Reference Table 1 for a description of available relay contacts for external wiring.

CONTACT LABEL	DESCRIPTION
NO	Normally-Open contact
COM	Common contact
NC	Normally-Closed contact

Table 1: External Alarm Interface

The system’s mode of operation is defined by a combination of two on-board controls – a 2-position slider-switch and a 3-position jumper field in accordance with Table 2. The label values shown refer to actual text on the PCB beneath their respective controls. It’s important to note that the labels represent the text that **remains visible** (unhidden) by either the slider or installed jumper **after** a selection is made. Reference section titled *System Modes* for further details of system mode differences.

SELECTED MODE	VISIBLE SLIDER-SWITCH LABEL	VISIBLE JUMPER LABEL
RUN	“RUN”	N/A
RUN	“SETUP”	“USER” and “FACTORY”
USER SETUP	“SETUP”	“USER”
FACTORY SETUP	“SETUP”	“FACTORY”

Table 2: System Mode Controls

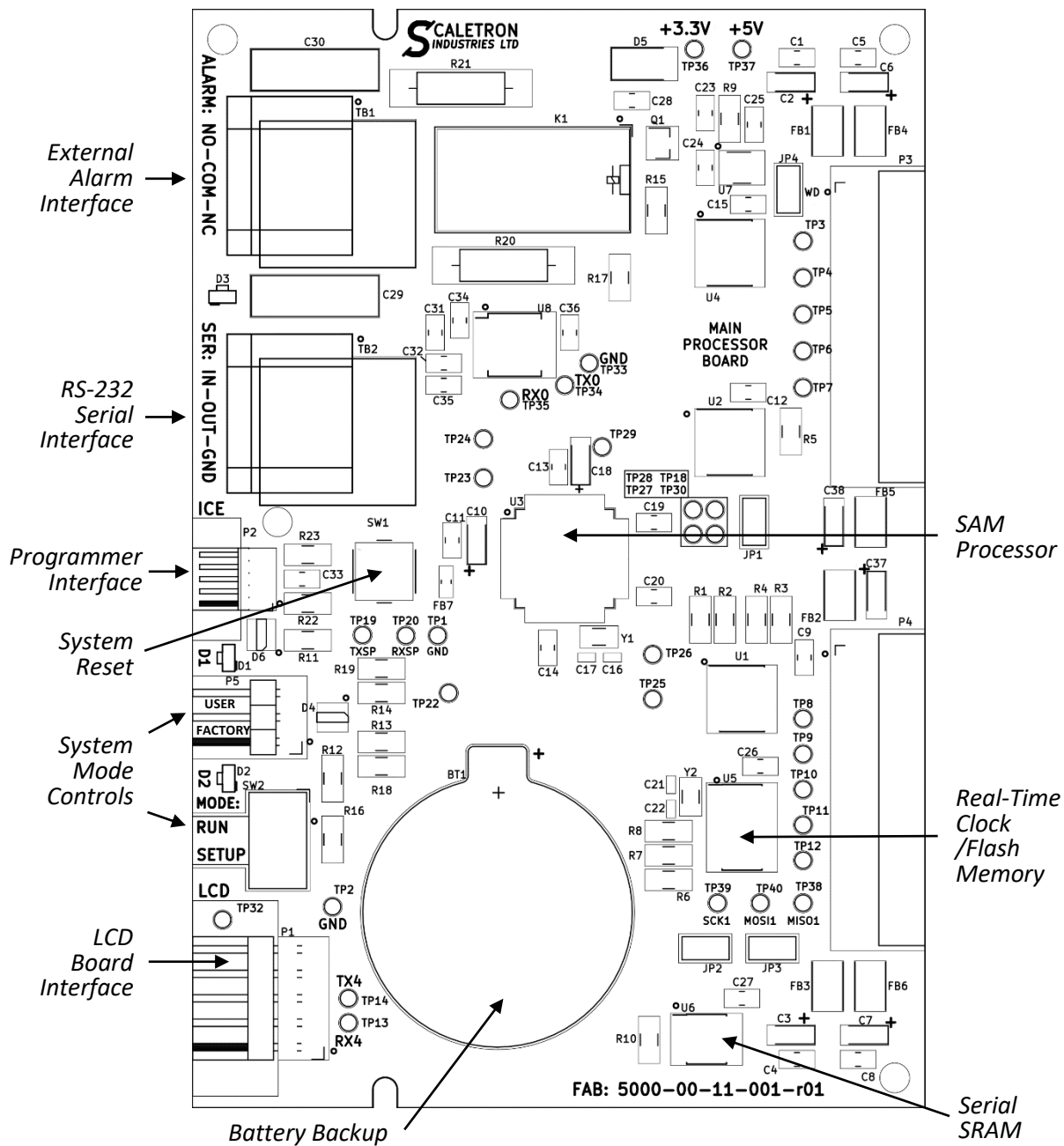

Figure 3: Main Processor Board

### 4.3.1 Features:

- External Alarm Interface:** A 3-pin relay port that includes a normally-open (NO), common (COM), and normally-closed (NC) contact allows for the use of an external AC/DC indicator for

Alarm notification. An associated LED indicates whether the state of the relay is energized (ON) or de-energized (OFF).

- **RS-232 Serial Interface:** A half-duplex serial interface for diagnostics and exporting of logged data.
- **Programmer Interface:** The SAM processor is programmed via an Atmel ICE. Model # ATATMEL-ICE, A09-2140/08.
- **System Reset:** Pressing this button asserts a system reset that reboots the microprocessor resulting in a systematic initialization of all peripheral hardware.
- **System Mode Controls:** A 2-position slider-switch and 3-pin jumper field define the mode of system operation.
- **LCD Board Interface:** The Main Processor Board communicates both control activity and display messages with the LCD Board via a full-duplex, RS-232 comm link.
- **Real-Time Clock:** A battery-backed time source that allows time-stamping of events. The device includes Flash Memory for storage of system configuration data.
- **SAM Processor:** Atmel #ATSAMD21J18A-AU containing internal EEPROM and SRAM.
- **SRAM:** Battery-backed static memory.

## 4.4 Analog Input Board

With reference to Figure 4, an AIB defines the existence of an active scale, or channel. The board includes two terminal block connectors for attaching load-cell and leak-detect sensor (optional) wires. The load-cell interface includes the signals shown in Table 3, which follow the industry standard for color-code of wires. Note that the interface does not include a connection for an optional cable shield wire, which should instead be attached to an earth-ground connection available on the power-supply bracket.

CONTACT LABEL	DESCRIPTION
RED	Positive terminal of +7.5 VDC Excitation voltage
GRN	Positive terminal of load-cell signal
WHT	Negative terminal of load-cell signal
BLK	Negative terminal of Excitation voltage

Table 3: Load-Cell Interface

The Scale-Base may be configured with a factory-installed leak-detect sensor for detection of liquid chemical spills. The available signals of the Leak-Detect Sensor Interface are shown in Table 4.

CONTACT LABEL	DESCRIPTION
GND	Digital Ground
/LD	Active-Low, Leak-Detect signal
+5V	+5 VDC supply voltage for external sensor

Table 4: Leak-Detect Sensor Interface

	<b>AccuPro-5000™ MEASUREMENT SYSTEM OPERATOR MANUAL</b>		
Issued by Department: Engineering	Doc. Number: 5000-00-00-002	Revision: 02	Effective Date: 10/05/2021

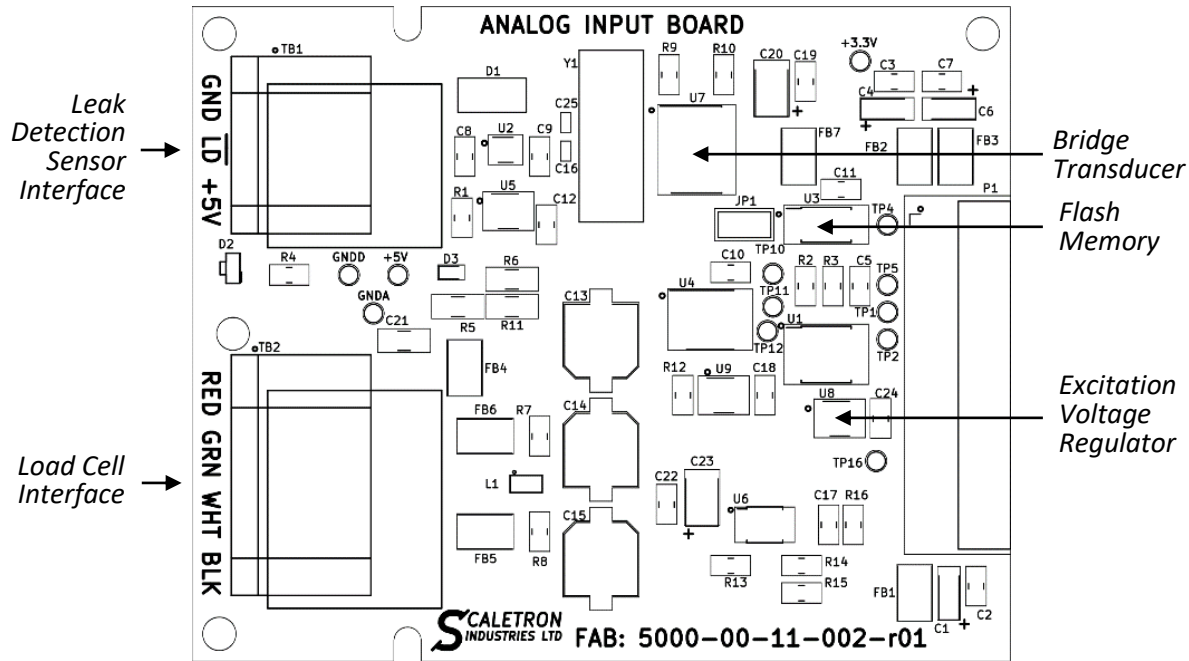

Figure 4: Analog Input Board

#### 4.4.1 Features:

- **Leak Detection Interface:** A 3-pin port that supplies a +5 VDC power source to an optional, external fluid sensor located on a scale base. An LED indicator reflects the real-time status of the fluid sensor; however, any assertion of the leak detection circuit will be latched as an Alarm condition which requires a user response in order to reset.
- **Load-Cell Interface:** A 4-pin port that supplies an excitation voltage to one or more load-cell bridges and receives back their summed output signal.
- **Flash Memory:** Non-volatile memory space used to store channel-specific calibration and configuration data for both the AIB and ROB.
- **Bridge Transducer:** A 24-bit Sigma Delta Analog-to-Digital Converter (ADC) that filters, amplifies, and converts a low-voltage, analog load-cell signal into a digital value.
- **Excitation Voltage Regulator:** Configured for +7.5 VDC @ 184 mA (maximum.) Offers ultra-low noise performance with a “power good” status output signal.

#### 4.5 Analog Output Board (4-20 mA Output)

With reference to Figure 6, the AOB-mA is an optional board that supports an industry standard, 4 to 20 mA current loop output. Its instantaneous current output is linearly proportional to the measurement value’s relative position between two user-defined limit values. External wire connections are made to the 2-position terminal block according to Table 5.

CONTACT LABEL	DESCRIPTION
+	Loop current source (ref to internal power source)
-	Loop current return (ref to internal power source)

Table 5: Current Loop Interface

The AOB also includes a slider-switch used to configure whether the current-loop’s power is derived internally by the scale (the text “SCALE” is visible next to the slider) or externally by a loop source (the text “LOOP” is visible next to the slider).

**WARNING: DO NOT CONFIGURE POWER SLIDER-SWITCH FOR INTERNAL “SCALE” SUPPLY IF AN EXTERNAL “LOOP” SUPPLY IS ALSO PRESENT. PERMANENT DAMAGE TO THIS CIRCUIT AND/OR EXTERNAL CIRCUITRY MAY OCCUR !**

It’s possible to power multiple loops using a common supply if the circuit is wired as depicted in Figure 5. Note that 24 VDC is the most common supply rating for this application.

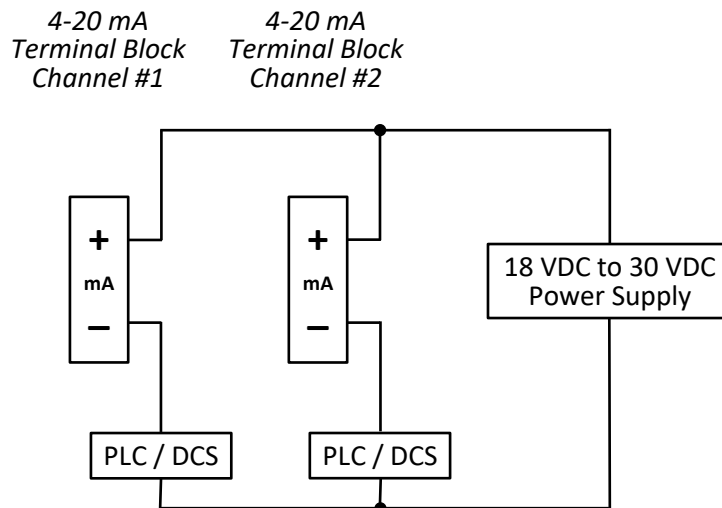



Figure 5: Multiple Current AOBs with Shared Loop Power Supply

	<b>AccuPro-5000™ MEASUREMENT SYSTEM OPERATOR MANUAL</b>		
Issued by Department: Engineering	Doc. Number: 5000-00-00-002	Revision: 02	Effective Date: 10/05/2021

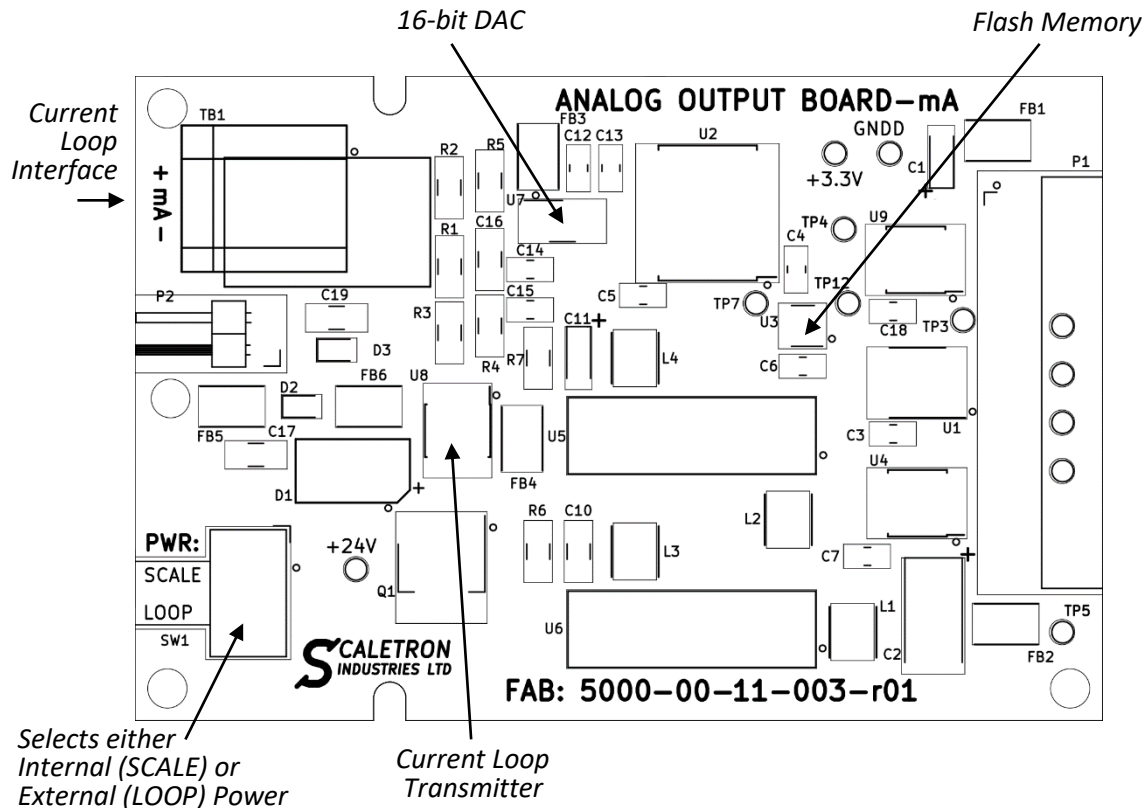

Figure 6: Analog Output Board - mA

#### 4.5.1 Features:

- **Current Loop Interface:** A 2-position connector to the current loop circuit.
- **Current Loop Transmitter:** A voltage-to-current converter.
- **Selectable Internal/External Power:** A 2-position slider switch that allows user-selection of the loop's power source. If the text "SCALE" is visible beneath the slider, the power is sourced internally by the AOB. If the text "LOOP" is visible, power is sourced externally by the user's loop supply.
- **Flash Memory:** 2k-bit of non-volatile memory used to store calibration and configuration data.
- **16-bit DAC:** A voltage-output, Digital-to-Analog Converter.

#### 4.6 Analog Output Board (0-5V/10V Output)

With reference to Figure 7, the AOB-V is an optional board that supports selectable 0-5V or 0-10V output range. Its instantaneous voltage output is linearly proportional to the measurement value's relative position between two user-defined limit values. External wire connections are made to the 2-position terminal block according to Table 6.

CONTACT LABEL	DESCRIPTION
+	Positive Voltage Output
-	Voltage Return

*Table 6: Voltage Output Interface*

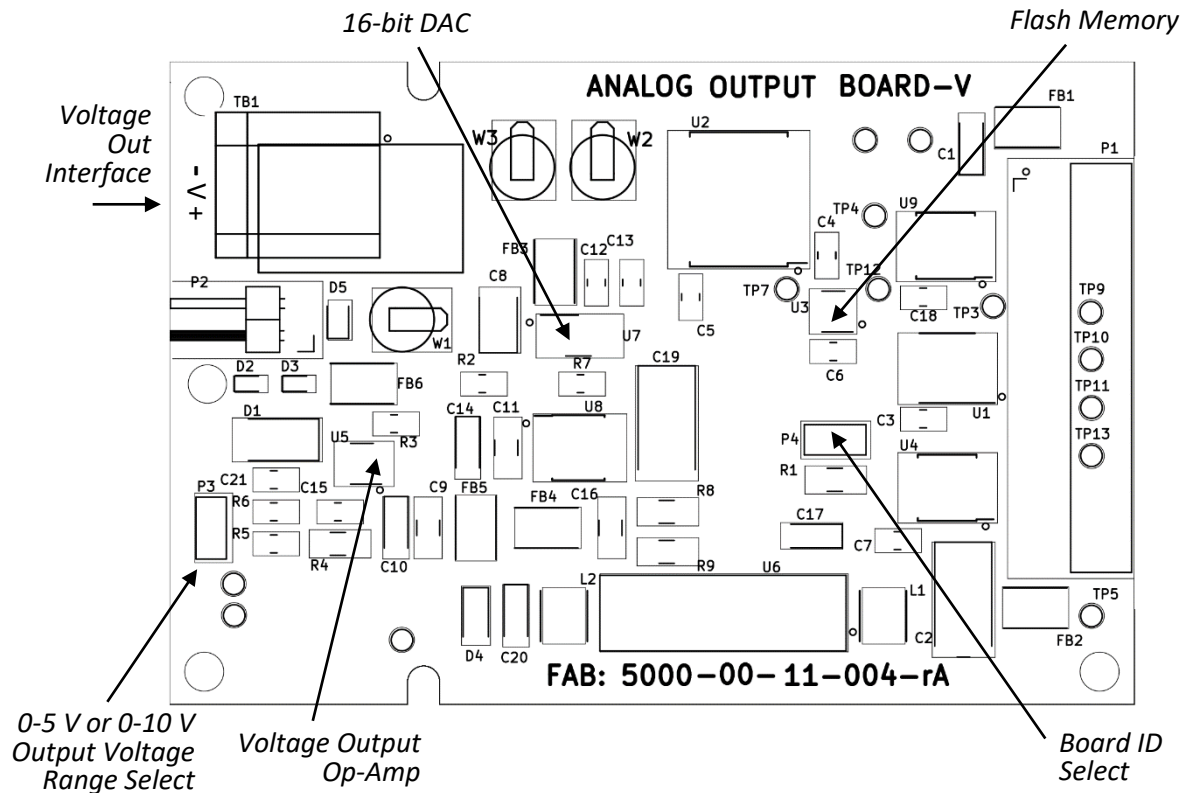

*Figure 7: Analog Output Board - V*

### 4.6.1 Features:

- **Voltage Out Interface:** A 2-position terminal-block connector to the voltage output circuit.
- **Output Voltage Range Select:** A jumper field that supports user selection of a voltage output range of either 0-5V or 0-10V. To select a 0-5V voltage output range, install a jumper-shunt on Jumper-Field P3. Remove any jumper shunt to select a 0-10V voltage output range.
- **Flash Memory:** 2k-bit of non-volatile memory used to store calibration and configuration data.
- **16-bit DAC:** A voltage-output, Digital-to-Analog Converter, whose output feeds a gain stage, voltage-output operational-amplifier.
- **Voltage Output Op-Amp:** An operational-amplifier that provides a voltage gain stage.
- **Board ID Select:** A jumper-field used to identify the configuration of the voltage range selection to the system processor. Its configuration should match that of the Output Voltage Range Select jumper-field to enable accurate menu option display messages.



## 4.7 Relay Output Board (Dual or Quad Relays)

With reference to Figure 8, the optional ROB offers two configurations – one having two relays (Dual) and another having four (Quad). A dual configuration supports relays numbered #1 and #2. A quad configuration supports relays numbered #1 through #4. The contacts of each relay are wired in a SPDT configuration as shown in Table 7, with external wire connections made accessible via a 3-position terminal block.

CONTACT LABEL	DESCRIPTION
NO	Normally-Open contact
COM	Common contact
NC	Normally-Closed contact

Table 7: Relay Interface

The relays are initialized in a negated, or de-energized, state following power-up. They are independently asserted, or energized, based on user-defined setpoints and other criteria. The assertion of a dedicated status LED indicates when the respective relay is energized.

Note that the ROB contains no Flash memory device, therefore all configuration data is saved to the respective channel's AIB.

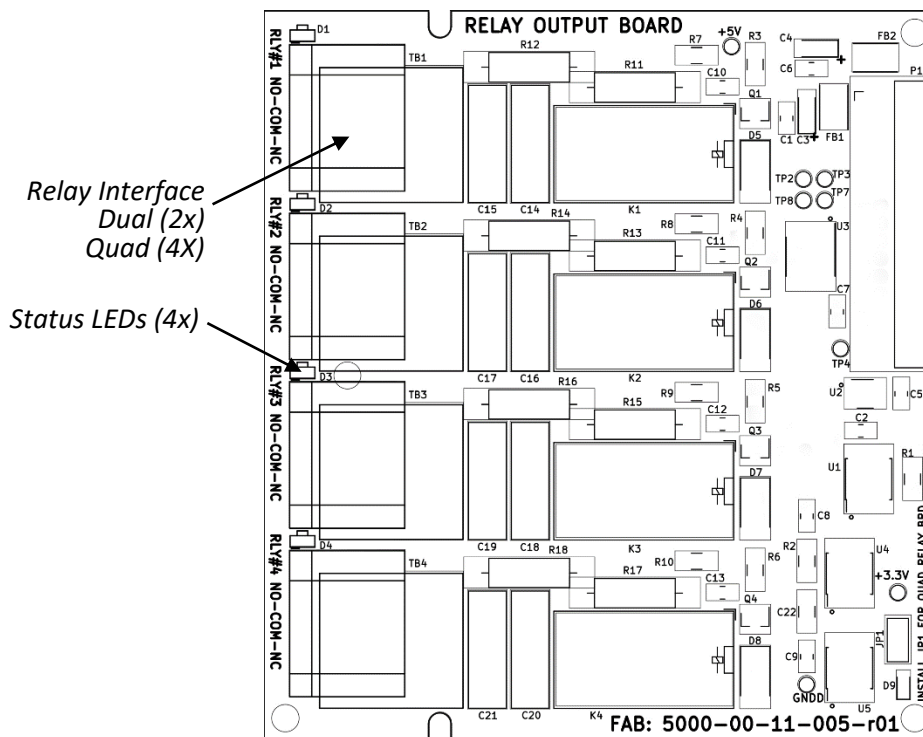



Figure 8: Relay Output Board



		<b>AccuPro-5000™ MEASUREMENT SYSTEM OPERATOR MANUAL</b>	
Issued by Department: Engineering	Doc. Number: 5000-00-00-002	Revision: 02	Effective Date: 10/05/2021

#### 4.7.1 Features:

- **Status LEDs:** Each relay has a dedicated status LED located next to its terminal block that indicates its current state as energized (ON) or de-energized (OFF).
- **Relay Interface:** A 3-position relay port that includes a normally-open (NO), common (COM), and normally-closed (NC) contact.

## 5 User Controls

A simplified set of external user-interface controls are utilized for both data entry and navigation through multiple calibration, configuration, and operational menus. Options include a multi-switch Keypad as depicted in Figure 9, or a bi-directional, Rotary Knob with an embedded press switch (not shown in figure.)

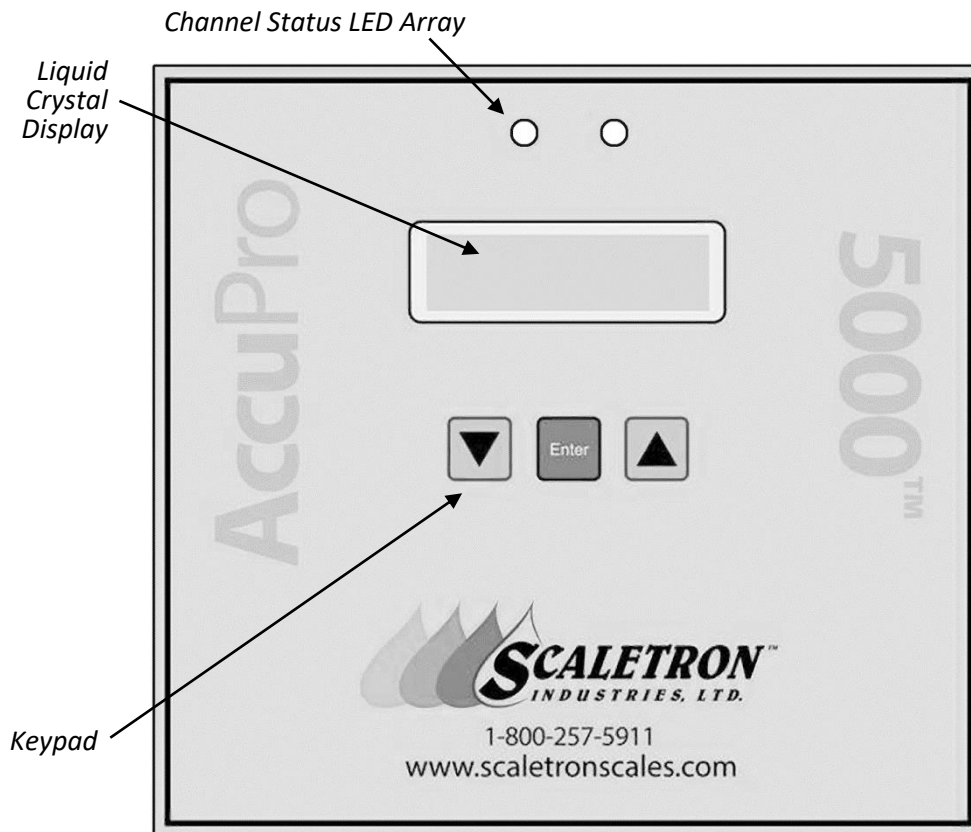



Figure 9: Control-Panel Overlay (Keypad Version)

		<b>AccuPro-5000™ MEASUREMENT SYSTEM OPERATOR MANUAL</b>	
Issued by Department: Engineering	Doc. Number: 5000-00-00-002	Revision: 02	Effective Date: 10/05/2021

## 5.1 Keypad

The Control-Panel overlay embeds a 1-row by 3-column matrix of membrane switches consisting of Down-Arrow, Enter, and Up-Arrow keys, respectively. A context-sensitive feature was added to the arrow keys wherein a press-and-hold action held for more than 2 seconds will initiate a fine auto-repeat of the respective key function whose rate gradually increases over the next 8 seconds, after which a much coarser auto-repeat is initiated. This feature is intended to greatly reduce the number of required key-presses when entering large numbers. Optional audible feedback is available that verifies control-switch closures (See main menu option titled *System Config.*)

- **Down-Arrow:** Press to advance backward through menu options or to decrement a numerical value.
- **Enter:** Press to “Select” a menu option or “Enter” a numerical value.
- **Up-Arrow:** Press to advance forward through menu options or to increment a numerical value.

## 5.2 Rotary Knob

A counter-clockwise (CCW) rotation of the Rotary Knob executes the same function as pressing the Down-Arrow key. Likewise, clockwise (CW) rotation mimics an Up-Arrow keypress. A sustained rotation of the knob initiates a repeat function of the respective function. Rotary Knob rotation is speed-sensitive, meaning that the faster its rotational speed, the faster the repeat function is performed. For example, a large numerical value can easily be entered by a rapid rotation of the Rotary Knob to place the value close to target, followed by a slower rotation to settle in on a final value. Once a desired menu option or numerical value is displayed, pressing the Rotary Knob will execute an “Enter” function.

## 6 User Indicators

A Liquid-Crystal-Display (LCD) Module and a Status Light-Emitting-Diode (LED) Array provide control information and alert/alarm notification to the user.

### 6.1 LCD Module

A 2-Line by 16-Character, alphanumeric/graphic LCD Module displays control menus, real-time measurement data, and status messaging information. The module features an adjustable contrast by way of an analog potentiometer located on the bottom side of the LCD Board. It also has an embedded LED panel for adjusting backlight intensity (See main menu option titled *System Config.*)

### 6.2 Channel Status LED Array

Each channel is assigned a bi-color, Status LED for indicating its high-level status. Each LED contains both a red and green element yielding four distinctive states: Off State (Inactive), Red State (Active/Alarm), Amber State (Active/Alert), and Green State (Active/Good). The indicated state is determined based on a set of hierarchical rules.

The Off State has the highest priority as it indicates the absence of an Analog Input Board – a minimal requirement for a channel to be considered present, or active. Any channel whose Status LED is OFF

		<b>AccuPro-5000™ MEASUREMENT SYSTEM OPERATOR MANUAL</b>	
Issued by Department: <b>Engineering</b>	Doc. Number: 5000-00-00-002	Revision: 02	Effective Date: 10/05/2021

represents a disabled or non-active channel despite the presence of optional boards associated with the respective channel.

The Red State has the highest priority for an active channel which indicates the assertion of an Alarm Status. An Alarm Status informs the user of a potential problem condition or pre-defined event which typically requires intervention before normal channel operation can resume. (See main menu option titled *Alerts/Alarms* for further details.)

The Amber State indicates the assertion of an Alert Status which has a lower priority than the Alarm Status. It is used to highlight events as configured by the user, but it can further assist a factory technician while performing calibration and configuration of a channel. It may also indicate a condition considered to be outside the recommended or operational parameters of the channel.

Finally, the Green State has the lowest priority which indicates that a channel is calibrated, configured, and ready for normal operation. Table 8 illustrates various situations and how their rated priority factors in to the LED status notification.

← HIGHER PRIORITY <i>Status Notification</i> LOWER PRIORITY →			
OFF	RED (Alarm Status)	AMBER (Alert Status)	GREEN (Ready Status)
<ul style="list-style-type: none"> <li>• Inactive Channel (No AIB Detected)</li> </ul>	<ul style="list-style-type: none"> <li>• Leak Detected</li> <li>• No Reference Voltage Detected</li> <li>• Reference Power Bad</li> <li>• Relay Setpoint asserted (Optional Configuration)</li> <li>• AIB Flash Error</li> <li>• AOB Flash Error</li> <li>• RTC Flash Error</li> </ul>	<ul style="list-style-type: none"> <li>• Relay Setpoint asserted (Optional Configuration)</li> <li>• Measurement Over Capacity</li> <li>• No AIB Configuration saved to Factory Flash</li> <li>• No AOB Configuration saved to Factory Flash</li> <li>• AIB Not Calibrated</li> <li>• AOB Not Calibrated</li> </ul>	<ul style="list-style-type: none"> <li>• Channel Ready</li> </ul>

*Table 8: Alerts/Alarms Priority Levels*

		<b>AccuPro-5000™ MEASUREMENT SYSTEM OPERATOR MANUAL</b>	
Issued by Department: Engineering	Doc. Number: 5000-00-00-002	Revision: 02	Effective Date: 10/05/2021

## 7 System Modes

System operation can take on one of several modes as defined by interior mode selection controls located on the Main Processor Board. A two-position, Mode Slider Switch and a three-pin, Setup Mode Jumper field are used to configure the mode as previously described in section titled *Main Processor Board*. Any run-time changes made to the mode selection controls are evaluated and acted upon whenever the user navigates through the main menu options by way of the Keypad or Rotary Knob. When such a mode change is detected, a temporary message will be displayed indicating the new mode. Each mode configuration offers the user a unique set of control menu options as detailed in section titled *System Main Menu*.

### 7.1 Run Mode

This is the normal operational mode as a measurement system and offers a minimal set of control options to the end-user. It is selected by moving the Mode Slider Switch into the Run Mode position, which is when the text “RUN” is visible beneath the slider. The configuration of the Setup Mode Jumper has no effect while in Run Mode.

### 7.2 Setup Mode

This mode enables additional control options depending on a specific purpose. It is selected by moving the Mode Slider Switch into the Setup Mode position, which is when the text “SETUP” is visible beneath the slider. A more specific setup mode is further selected via placement of a shorting-shunt on a 3-pin, Setup Mode Jumper field.

**NOTE:** *If the Mode Slider Switch is in the SETUP position, a shorting-shunt MUST be placed on the Setup Mode Jumper to further select the setup mode. The absence of a shorting-shunt will keep system operation in Run Mode.*

- User Setup Mode:** This is a high-level setup mode that offers the end-user limited access to system menu options that augment the normal operation of the system. It is selected by installing a shorting-shunt on the 3-pin, Setup Mode Jumper such that the text “USER” remains visible within the jumper field.
- Factory Setup Mode:** This is a low-level setup mode that offers a factory technician greater access to system menu options needed during system assembly and calibration. It is selected by installing a shorting-shunt on the 3-pin, Setup Mode Jumper such that the text “FACTORY” remains visible within the jumper field.

		<b>AccuPro-5000™ MEASUREMENT SYSTEM OPERATOR MANUAL</b>	
Issued by Department: Engineering	Doc. Number: 5000-00-00-002	Revision: 02	Effective Date: 10/05/2021

## 8 System Main Menu

When navigating through main menu options, the top line of the LCD Module displays the menu's title as shown in Figure 10. The presence of an Up/Down Arrow symbol following the title indicates that additional menu options are available by scrolling via the Arrow Keys or Rotary Knob. An option is selected by asserting "ENTER" – achieved by pressing either the Enter Key or the Rotary Knob. The bottom line of a menu display can either present options to the user or request information from the user, such as selecting a specific channel, choosing a configuration option, or entering a numerical value. In some cases, Up and/or Down-Arrow symbols will appear at the end of an option or data field. When only an Up-Arrow is present, it indicates that the current numerical option or value being entered is at its lowest supported value, thus the value can only be increased. Similarly, a lone Down-Arrow indicates the current value is at its maximum. Simultaneous Up and Down-Arrows indicate that either a limit has not been reached, or the selection of options will loop continuously as the user indexes or scrolls in either direction.

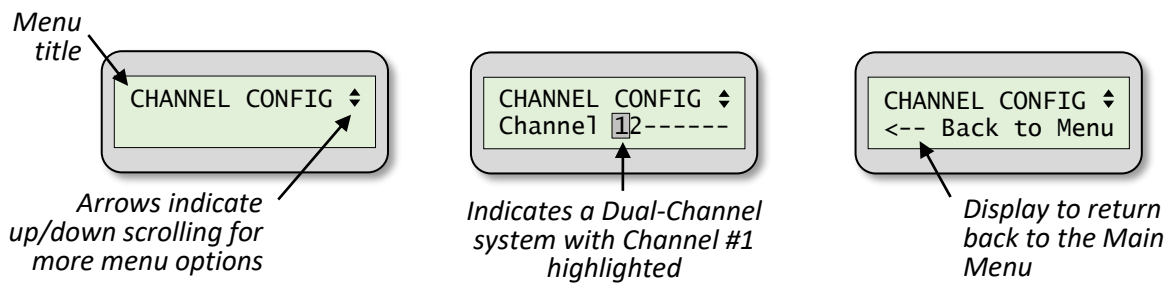

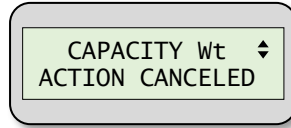

Figure 10: System Menu Displays

When a submenu is first entered in a multi-channel system, the user must identify the channel for which to perform the respective option. The display will indicate all applicable channels for the specific menu selection, with a blinking cursor hovering over the lowest numbered channel. Non-applicable channel locations are indicated by a dash, “-“. The user must use the Arrow Keys or Rotary Knob to scroll through the applicable channels and highlight the desired channel number with the blinking cursor. If the blinking cursor is scrolled past the list of channels on either end, an opportunity to “<-- Return to Menu” is presented. Upon selection of a channel, the respective channel number will be placed in the upper-left corner of the display for the remainder of the procedure. Upon completion of the procedure, the user is given the opportunity to select another channel and repeat the procedure, or return back to the main menu as previously described.

If the “ENTER” action is held pressed for more than two seconds when making any selection, the message “ACTION CANCELED” will temporarily appear on the display. See Figure 11. Any configuration changes made within the current submenu, except those that execute Flash operations, will be canceled and the remainder of the submenu procedure will be terminated. This provides a clean method to “exit out” of a given submenu should it be entered accidentally or configured incorrectly.

	<b>AccuPro-5000™ MEASUREMENT SYSTEM OPERATOR MANUAL</b>		
Issued by Department: <b>Engineering</b>	Doc. Number: 5000-00-00-002	Revision: 02	Effective Date: 10/05/2021



*Figure 11: Action Canceled Display*

Table 9 summarizes System Menu options as a function of the System Mode configuration.



# AccuPro-5000™ MEASUREMENT SYSTEM OPERATOR MANUAL

Issued by Department:  
Engineering

Doc. Number:  
5000-00-00-002

Revision:  
02

Effective Date:  
10/05/2021

Table 9: Operational Menu Tree

SYSTEM MENU OPTIONS	RUN MODE	SETUP MODES <sup>(1)</sup>	
		USER	FACTORY
<b>Scale Display</b>	X	X	X
<b>Alerts / Alarms <sup>(2)</sup></b>	X	X	X
<b>Dead Weight</b>			X
<b>Calibrate Weight</b>			
<i>Set Units</i>			X
<i>Set Value (x4)</i>			X
<b>Capacity Weight</b>			
<i>Set Units</i>			X
<i>Set Value</i>			X
<b>System Config</b>			
<i>Factory Restore <sup>(3)</sup></i>			X
<i>Set Secure Tare</i>		X	X
<i>Set Keypress Buzzer</i>		X	X
<i>Set Alarm Buzzer</i>		X	X
<i>Set LCD Backlight Intensity</i>		X	X
<i>Configure Serial Out Port</i>		X	X
<b>Channel Config</b>			
<i>Factory Restore <sup>(3)</sup></i>			X
<i>Set Measurement Units</i>		X	X
<i>Set Decimal Places</i>		X	X
<i>Set Sample #/Average</i>		X	X
<i>Set Bar-Graph</i>		X	X
<b>Liquid Mass <sup>(4)</sup></b>			
<i>Set Density or Specific Gravity</i>		X	X
<i>Set Density Units</i>		X	X
<i>Set Liquid Mass Value</i>		X	X
<b>Tare Adjust</b>			
<i>Set Units</i>	X <sup>(5)</sup>	X	X
<i>Set Value</i>	X <sup>(5)</sup>	X	X
<b>Relay Setpoint <sup>(6)</sup></b>			
<i>Select Relay #</i>		X	X
<i>Set Status</i>		X	X
<i>Set Units</i>		X	X
<i>Set Setpoint Value (x2, x4)</i>		X	X
<i>Set Limit High or Low (x2, x4)</i>		X	X
<i>Set Mode Free-Run or Latching (x2, x4)</i>		X	X
<i>Set Audible Alarm <sup>(7)</sup> (x2, x4)</i>		X	X
<b>mA/V Output <sup>(8)</sup></b>			
<i>mA/Volts-Output Calibration (x2)</i>			X
<i>Set mA/V Setpoints (x2)</i>		X	X
<b>Real-Time Clock</b>			
<i>Set Time</i>		X	X
<i>Set Date</i>		X	X
<i>Set Trim Value (Oscillator Calibration)</i>			X
<b>About</b>			
<i>Software Version #(s)</i>		X	X
<i>Current Time/Date</i>		X	X
<i>Current System Mode</i>		X	X

- NOTES:**
- (1) If User or Factory Setup Mode not properly configured, the system defaults to Run Mode
  - (2) Option available only if an Alert/Alarm condition has been detected
  - (3) Option available only if Factory configuration was previously saved into non-volatile memory
  - (4) Option available only if a "Volume" display unit is selected for an active channel
  - (5) Applicable only if Secure Tare is disabled
  - (6) Option available only if a Dual/Quad Relay Output Board is detected
  - (7) Option available only if a Latching Mode was enabled
  - (8) Option available only if a mA/V Analog Output Board is detected

		<b>AccuPro-5000™ MEASUREMENT SYSTEM OPERATOR MANUAL</b>	
Issued by Department: Engineering	Doc. Number: 5000-00-00-002	Revision: 02	Effective Date: 10/05/2021

## 8.1 Scale Display

Select this menu option by pressing the Enter Key while the display appears as shown in Figure 12.

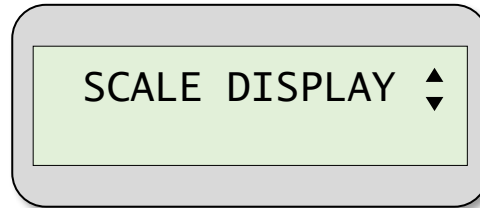
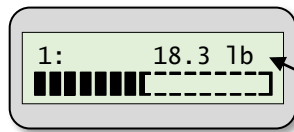

Figure 12: SCALE DISPLAY Menu Option

This menu is responsible for displaying the real-time, averaged scale-measurement value for all active channels in the system. Given the LCD Module is a 2-line display, the measurement values for up to two channels can be displayed simultaneously. For systems configured with multiple active channels, the user can scroll through the display of measured values for all available active channels. The number of the respective active channel(s) will be presented as the left-most character of each applicable row of the display as shown in Figure 13.

Single-Channel Display with Bar-Graph  
"ENABLED"



Realtime  
Scale  
Measurement

Dual-Channel Display with Bar-Graph  
"DISABLED"

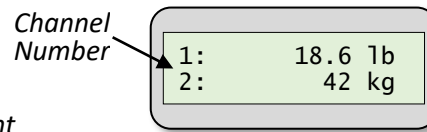

Figure 13: Single versus Dual-Channel Measurement Display

Whenever a given channel is configured to enable its proportional bar-graph (See main menu option titled *Channel Config*), only the data for that channel will be displayed. The top line will present the average measured numerical value, while the bottom line will depict its proportional bar-graph.

Pressing the Enter Key or Rotary Knob will exit Scale Display and allow scrolling through additional main menu options as a function of the current System Mode configuration.

## 8.2 Alerts/Alarms

Select this menu option by pressing the Enter Key while the display appears as shown in Figure 14.



		<b>AccuPro-5000™ MEASUREMENT SYSTEM OPERATOR MANUAL</b>	
Issued by Department: <b>Engineering</b>	Doc. Number: 5000-00-00-002	Revision: 02	Effective Date: 10/05/2021

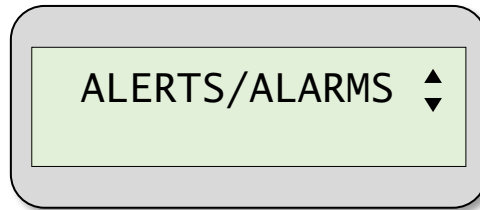

*Figure 14: ALERTS/ALARMS Menu Option*

This menu option is only available when either an Alert or Alarm condition has been detected. An Alert condition is the occurrence of a predefined state that is visually brought to the attention of the user by way of a display message and/or Status LED notification. Alert notifications represent a real-time status, meaning they are free-running and able to update as trigger conditions change. In contrast, an Alarm condition is one that carries a higher priority than an Alert. An Alarm can be viewed as a latching Alert, that is, one that requires the user to first acknowledge before the notification is reset, even if the condition(s) that first triggered the Alarm have subsequently changed.

### **8.2.1 Procedure**

The set of supported Alert and Alarm notifications are depicted in Figure 15. The presence of simultaneous Up and Down-Arrows at the end of a notification signifies that multiple conditions may have contributed to the assertion. Use the controls to scroll through the messages.

### Alert Message Examples

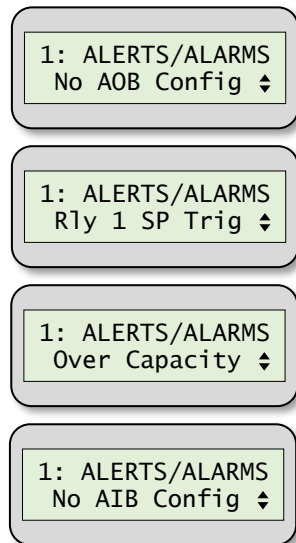

### Alarm Message Examples

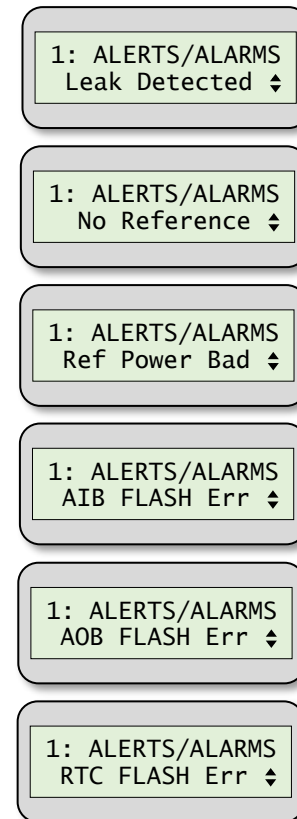



Figure 15: ALERTS / ALARMS Messages

The list of supported Alerts and Alarms include the following:

- **Leak Detected:** (Alarm) Indicates detection of a possible fluid leak on the respective channel's scale base.
- **No Reference:** (Alarm) Indicates a possible loss of the reference-voltage to the Bridge Transducer (AD7730 device) on the respective channel's Analog Input Board.
- **Reference Power Bad:** (Alarm) Indicates a possible loss of output from the reference-voltage regulator (LT3042 device) on the respective channel's Analog Input Board.
- **AIB FLASH Err:** (Alarm) Indicates a possible Flash memory write operation error to the respective channel's Analog Input Board.
- **AOB FLASH Err:** (Alarm) Indicates a possible Flash memory write operation error to the respective channel's Analog Output Board.
- **RTC FLASH Err:** (Alarm) Indicates a possible Flash memory write operation error to the system's Real-Time Clock device.
- **No AIB Configuration:** (Alert) Indicates that Factory calibration and configuration data was not yet saved into the Analog Input Board's (AIB) Flash memory.

		<b>AccuPro-5000™ MEASUREMENT SYSTEM OPERATOR MANUAL</b>	
Issued by Department: Engineering	Doc. Number: 5000-00-00-002	Revision: 02	Effective Date: 10/05/2021

- **No AOB Configuration:** (Alert) Indicates that Factory calibration and configuration data was not yet saved into the Analog Output Board's (AOB) Flash memory.
- **Over Capacity:** (Alert) Indicates that the scale measurement exceeds the system's maximum capacity as configured during factory calibration, and therefore may represent an invalid value. The displayed measurement value will also blink during this condition.
- **Relay Setpoint Triggered:** (Alert / Optional Alarm) Indicates that a scale measurement crossed the setpoint threshold as predefined by the user.

The assertion of an Alarm condition triggers the External Alarm Relay located on the Main Processor Board. The relay is AC/DC rated and provides normally-open, common, and normally-closed contacts for the user to connect to an external indicator of their choice. An Alarm condition can also be configured to trigger an internal buzzer (See main menu option titled *System Config.*) Once asserted, the External Alarm Relay and internal buzzer, if enabled, will be negated (silenced) when the Alerts/Alarms menu is first entered. They will remain negated even if the trigger conditions that first asserted them still remain.

In a dual-channel system, the display will identify which channels are indicating an Alerts/Alarms condition. The user must first select a desired channel to be evaluated before scrolling through all the messages for the respective channel. Whenever the displayed message pertains to an Alarm condition, its respective latched state is negated, or reset. Upon exiting the Alerts/Alarms menu, the system status will be re-evaluated before updating the Alerts/Alarms status notification.

### 8.3 Dead Weight

Select this menu option by pressing the Enter Key while the display appears as shown in Figure 16.

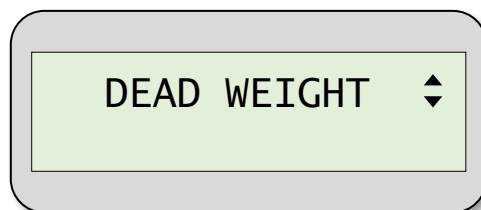

Figure 16: DEAD WEIGHT Menu Option

This menu provides a factory technician a means to reduce an unwanted component of the load-cell's output voltage attributed to the weight of the scale's physical base itself. The procedure is not performed by entering an actual weight value, but rather involves adjusting the value of the Bridge Transducer's internal 6-bit Offset Digital-to-Analog Converter (DAC) to "offset" any unwanted input voltage when the scale is unloaded. In this manner, a greater working bandwidth is made available for resolving the desired scale measurement via the internal 24-bit Analog-to-Digital Converter (ADC). During Dead Weight DAC adjustment, the analog gain level is configured to maximum for increased sensitivity, while the Zero-Offset and Gain (Full-Scale) Calibration registers are set to default (neutral) values. Following entry of the Dead Weight DAC adjustment, a working set of calibration values are computed and stored for each of four analog gain levels.

### 8.3.1 Procedure

The procedure for navigating the Dead Weight submenu follows the control flow diagram depicted in Figure 17.

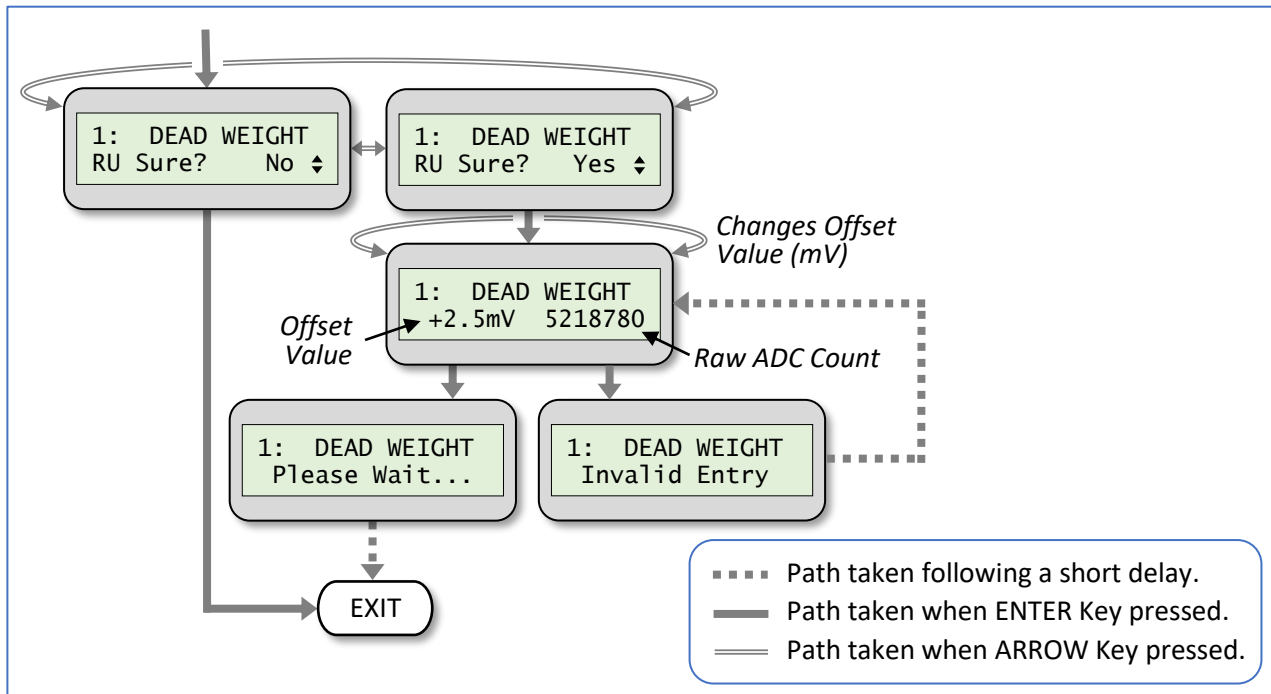



Figure 17: DEAD WEIGHT Control Flow Diagram

- For a dual-channel system, first select the desired channel for which to conduct the procedure. The number of any chosen active channel will be indicated in the upper-left corner of the display for the remainder of this submenu.
- Given that Dead Weight adjustment requires that accurate weight calibration procedures immediately follow, the user is first asked to confirm the menu selection via an “RU Sure?” prompt, for “Are You Sure?” A “Yes” response will continue with the procedure; a “No” response will exit the submenu.
- The applied voltage offset representation of the internal 6-bit DAC Offset value is displayed on the bottom line, left side. This is a bipolar value in mV units, having 31 steps in each direction, from zero, yielding a range of (-77.5 mV to +77.5 mV) with a step size of  $77.5/31 = 2.5$  mV. This voltage is internally added to the input voltage from the selected channel’s load cell(s).
- The decimal representation of the real-time, raw 24-bit ADC count is also displayed on the bottom line, right side. The value is the average of 100 randomized samples to help smooth any signal fluctuations. This is a unitless, positive value having a range of 0 to 16,777,215 (0x0 to 0xFF FFFF).
- Use the Arrow Keys or Rotary Knob to adjust the DAC Offset value to minimize the ADC count value WITHOUT clipping it to 0. If a clipped value is entered, an “Invalid Entry” message is momentarily displayed prior to providing the user another opportunity to re-enter a valid value.

		<b>AccuPro-5000™ MEASUREMENT SYSTEM OPERATOR MANUAL</b>	
Issued by Department: Engineering	Doc. Number: 5000-00-00-002	Revision: 02	Effective Date: 10/05/2021

- f. Once the Dead Weight adjustment is entered, a “Please Wait...” message is displayed while the system begins performing an internal self-calibration for zero-offset and full-scale gain for each of the four analog gain levels. This process will complete within 40 seconds (approx.), at which point control will return to the main menu.

## 8.4 Calibrate Weight

Select this menu option by pressing the Enter Key while the display appears as shown in Figure 18.

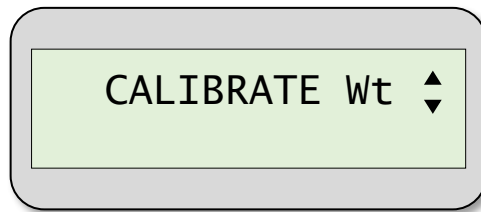

*Figure 18: CALIBRATE WEIGHT Menu Option*

Entry of Calibration Weights generally requires that known, accurate weight(s) be physically placed on the scale. The purpose is to correlate a unitless value read from the AD7730 to an actual absolute measurement value. Given there are four transfer curves (one for each analog gain level), there can be up to four unique Calibration Weight values. For best results, the known calibration weight should represent a large percentage of the available range for a given gain level WITHOUT exceeding the maximum weight that the load cell(s) can support.

### 8.4.1 Procedure

The procedure for navigating the Calibrate Weight submenu follows the control flow diagram depicted in Figure 19.

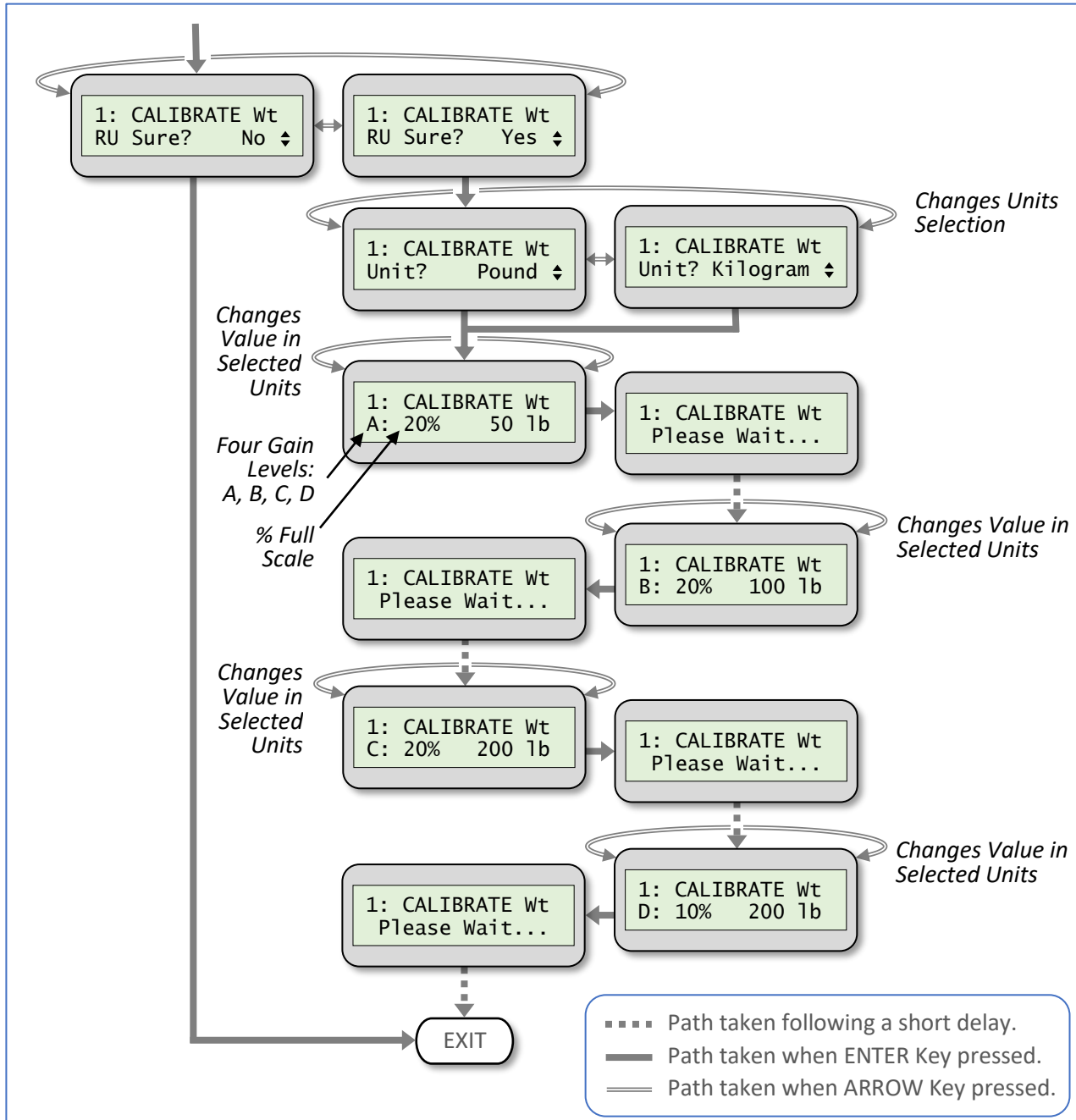



Figure 19: CALIBRATE WEIGHT Control Flow Diagram

- a. Access to this menu requires that the Dead Weight calibration procedure be completed. The user is prompted via a display message (Not shown in Control-Flow diagram) to first enter any missing required parameters.

		<b>AccuPro-5000™ MEASUREMENT SYSTEM OPERATOR MANUAL</b>	
Issued by Department: Engineering	Doc. Number: 5000-00-00-002	Revision: 02	Effective Date: 10/05/2021

- b. For a dual-channel system, first select the desired channel for which to conduct the procedure. The number of any chosen active channel will be indicated in the upper-left corner of the display for the remainder of this submenu.
- c. Given the importance of proper Calibration Weight entry and the fact that it requires access to calibration weight(s), the user is first asked to confirm the menu selection via an “RU Sure?” prompt, for “Are You Sure?” A “Yes” response will continue; a “No” response will exit the submenu.
- d. Select and enter the desired units for the known calibration weight(s). Only pounds (lb) or kilograms (kg) are valid.
- e. With calibration weight(s) physically placed on the scale, enter the known Calibration Weight value(s) in the previously-selected units for each of the four gain levels, designated on the display as “A” (maximum gain) through “D” (minimum gain). The real-time, percent of full-scale of the ADC output will be displayed to highlight the resolvable upper limit. It is recommended that the percentage of full-scale value does not exceed 90% in order to maintain an operating margin. If the average calibration measurement is near saturation, a load cell may be disconnected. If the average calibration measurement is near zero, a load cell may be shorted. Each of these scenarios will cause the message “Check Load Cells” to be temporarily displayed before returning back to the calibration procedure. Inspect the load cell(s) before continuing.
- f. By definition, a Calibration Weight value must exceed the respective Dead Weight value for each analog gain level. If this condition is not met, an “Invalid Entry” message is momentarily displayed (Not shown in Control-Flow diagram) prior to providing the user an opportunity to increase the calibration weight.

## 8.5 Capacity Weight

Select this menu option by pressing the Enter Key while the display appears as shown in Figure 20.

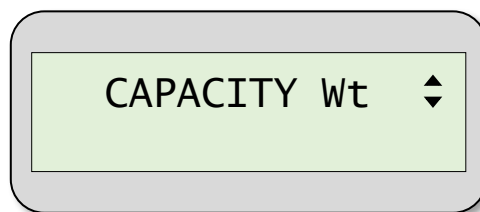



Figure 20: CAPACITY WEIGHT Menu Option

There are three distinct gross capacity weight values that need to be understood, referred herein as Physical Capacity, Hardware Capacity, and Working Capacity. A Physical Capacity Weight represents the maximum gross weight that the Scale-Base and combined load cells can withstand without suffering permanent mechanical damage via bending of metal. Conversely, the gross Hardware Capacity is the maximum weight that the system’s hardware, or electronics, can resolve without exceeding the upper limit of its working range. Note that Hardware Capacity Weight can be less than or greater than the Physical Capacity Weight. Finally, the gross Working Capacity Weight represents the maximum working gross weight that the system is designed to support, including any Tare Weight component, per customer requirements and factory-limited specification. This submenu is for entering a gross Working Capacity Weight, hereafter referred to as simply Capacity Weight. Its value **MUST ALWAYS** be less than

		<b>AccuPro-5000™ MEASUREMENT SYSTEM OPERATOR MANUAL</b>	
Issued by Department: Engineering	Doc. Number: 5000-00-00-002	Revision: 02	Effective Date: 10/05/2021

both the Physical and Hardware Capacity values. The precision, or number of decimal places, of the displayed Capacity Weight value will match that previously configured for the respective channel within the *Channel Config* menu.

### 8.5.1 Procedure

The procedure for navigating the Capacity Weight submenu follows the control flow diagram depicted in Figure 21.

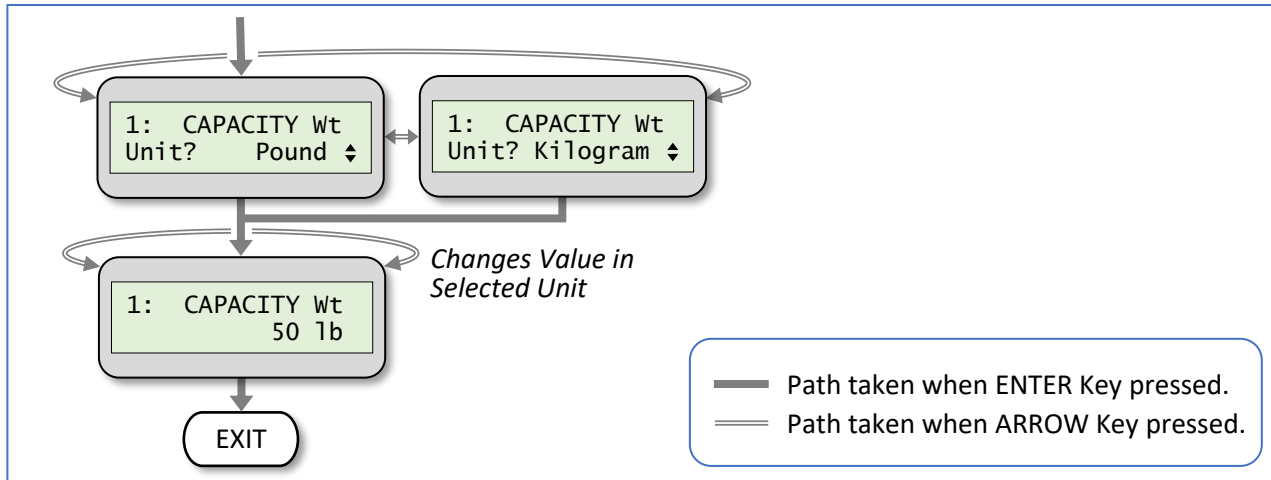



Figure 21: CAPACITY WEIGHT Control Flow Diagram

- Access to this menu requires that both the Dead Weight and Calibration Weight procedures be completed. The user is prompted via a display message (Not shown in Control-Flow diagram) to first enter any missing required parameters.
- For a dual-channel system, first select the desired channel for which to conduct the procedure. The number of any chosen active channel will be indicated in the upper-left corner of the display for the remainder of this submenu.
- Select and enter the desired units for Capacity Weight. Only pounds (lb) or kilograms (kg) are valid.
- Enter the gross Capacity Weight in the previously-selected units. The displayed default value will match the Calibration Weight entered when the analog gain value was set to maximum given it theoretically could be used to calibrate at all gain levels. The supported range for Capacity Weight is from 1 up to a computed, theoretical Hardware Capacity Weight, less 1.
- Following entry of a Capacity Weight, the system will evaluate the data to determine the optimal analog gain level from which to operate. This will represent the highest gain level that would not cause saturation of the ADC output value for the entered Capacity Weight.

## 8.6 System Config

Select this menu option by pressing the Enter Key while the display appears as shown in Figure 22.



		<b>AccuPro-5000™ MEASUREMENT SYSTEM OPERATOR MANUAL</b>	
Issued by Department: <b>Engineering</b>	Doc. Number: <b>5000-00-00-002</b>	Revision: <b>02</b>	Effective Date: <b>10/05/2021</b>

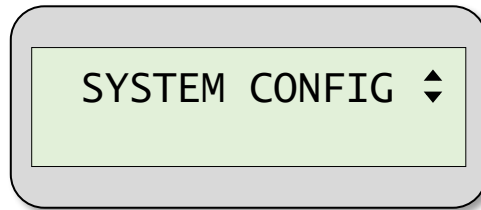

*Figure 22: SYSTEM CONFIGURATION Menu Option*

This menu offers a set of system-level configuration options. That is, these options are not channel-specific, but rather general in scope and apply to all active channels. Option selections are saved to non-volatile memory located on the Main Processor Board. Once this menu has been entered, the user is forced to answer the entire suite of submenu configuration options, even if the intent is to modify only one of them. The default configuration for each option is its current value, thus pressing the Enter Key each time will maintain their current status.

### **8.6.1 Procedure**

The procedure for navigating the System Configuration submenu follows the control flow diagram depicted in Figure 23.

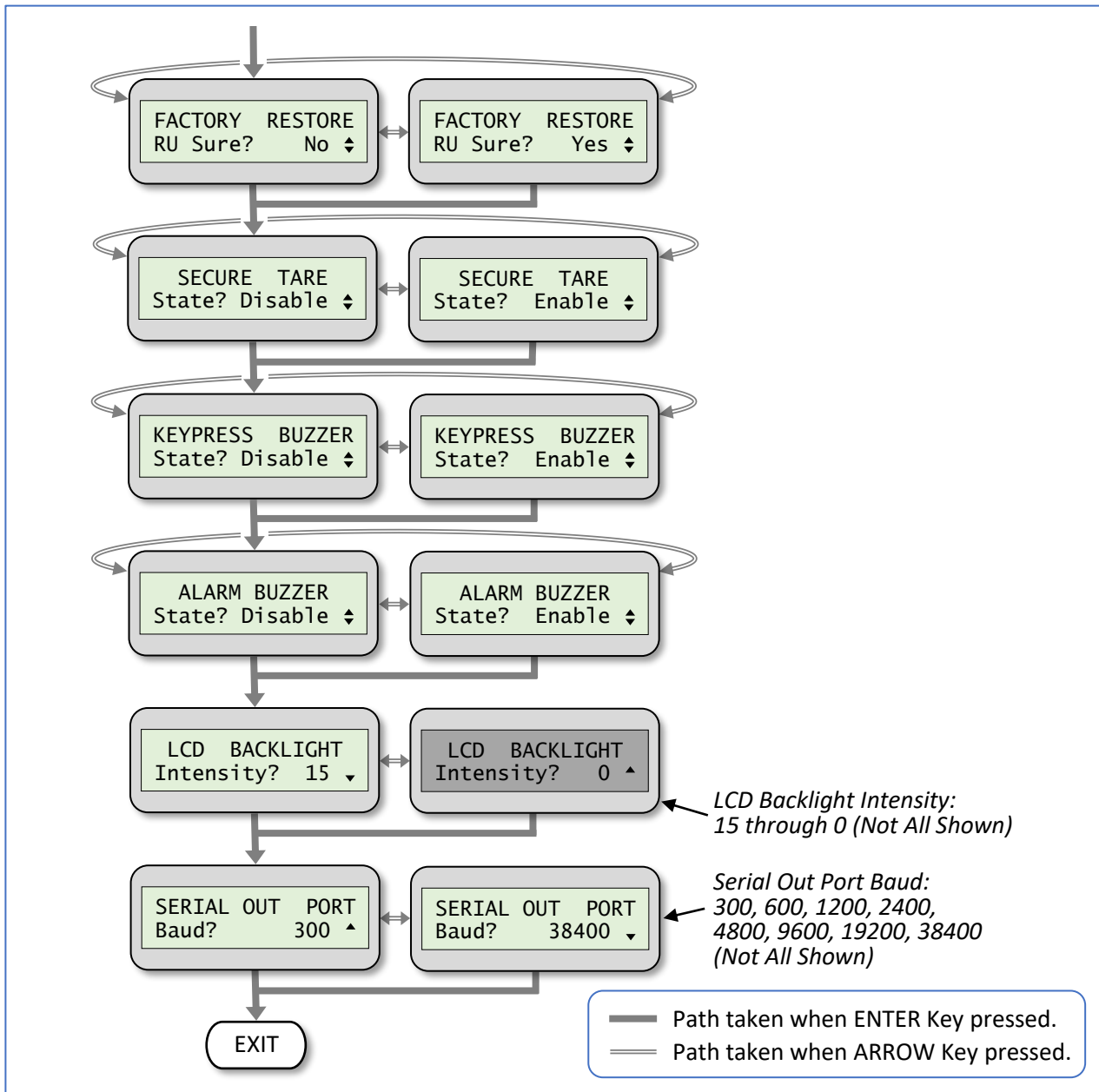



Figure 23: SYSTEM CONFIGURATION Control Flow Diagram

- a. Depending on the System Mode configuration, the option to restore the Factory settings of ALL channels from non-volatile Flash memory for use as new system settings is presented. Given the system impact of this option, the user is first asked to confirm their selection by responding to an “RU Sure?” prompt, for “Are You Sure?” A “Yes” response will continue; a “No” response will exit the option. The Factory Restore operation is intended to read back all the channel-specific, calibration and configuration data previously saved to protected Flash memory via a Factory Save operation. If a Factory Save operation was not previously performed on a given channel, the Factory

		<b>AccuPro-5000™ MEASUREMENT SYSTEM OPERATOR MANUAL</b>	
Issued by Department: Engineering	Doc. Number: 5000-00-00-002	Revision: 02	Effective Date: 10/05/2021

Restore operation will be terminated for the respective channel and a temporary error message (Not shown on Control-Flow diagram) will be displayed. Be advised that once executed, this action cannot be canceled or reversed.

- b. Select and enter the desired state of Secure Tare. If “Enable” is selected, the ability to make tare adjustments will be denied when the system is in RUN Mode. This prevents an unauthorized user from altering its value during normal operation. Instead, the current tare value will be displayed. If “Disable” is selected, user-adjustment of the tare value will be supported when the system is in RUN Mode during normal operation.
- c. Select and enter the desired state of the Keypress Buzzer. If “Enable” is selected, the Internal Buzzer will be momentarily energized as audible feedback each time a keypad button is pressed. If “Disable” is selected, the Internal Buzzer will not be activated in response to a keypress.
- d. Select and enter the desired state of the Alarm Buzzer. If “Enable” is selected, the Internal Buzzer will be energized to signal Alarm conditions, some of which are user-selectable. If “Disable” is selected, the Internal Buzzer will remain de-energized, or OFF, during active alarm states.
- e. Select and enter an LCD backlight intensity to 1 of 16 levels, with “15” corresponding to the brightest level and “0” to the dimmest. The backlight intensity will track the adjustment value in real-time.
- f. Select and enter the desired Serial Output Port baud rate.

## 8.7 Channel Config

Select this menu option by pressing the Enter Key while the display appears as shown in Figure 24.

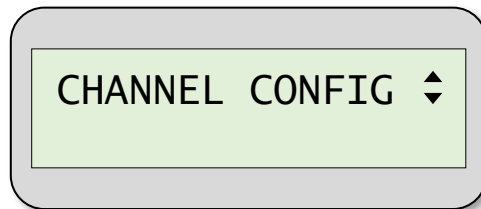

Figure 24: CHANNEL CONFIGURATION Menu Option

This menu offers a set of channel-specific, configuration options for a selected active scale. Option selections are saved to non-volatile memory located on the respective channel’s Analog Input Board. Once this menu has been entered, the user is forced to answer the entire suite of submenu configuration options, even if the intent is to modify only one of them. The default configuration for each option is its current value, thus pressing the Enter Key each time will maintain their current status.

### 8.7.1 Procedure

The procedure for navigating the Channel Configuration submenu follows the control flow diagram depicted in Figure 25.

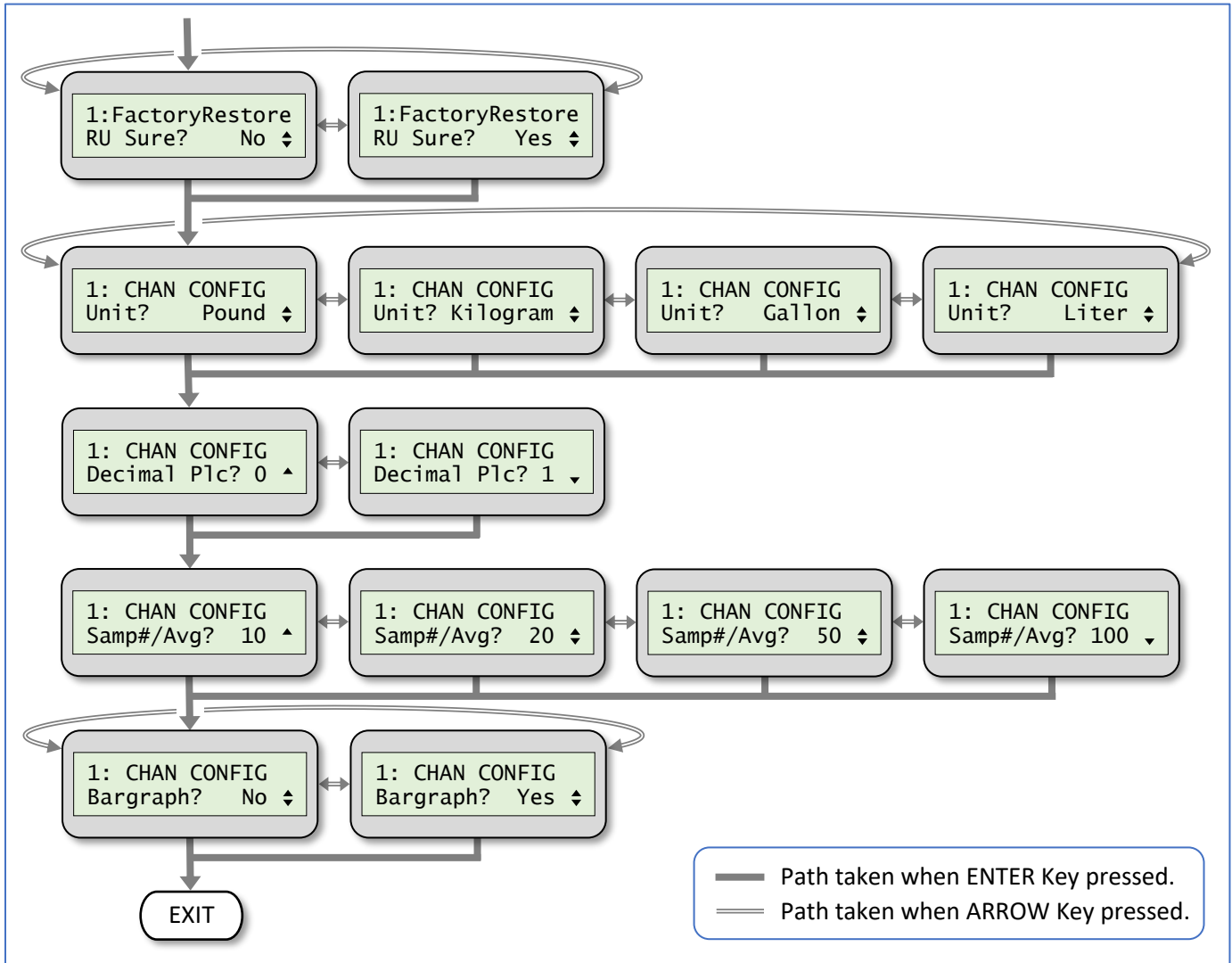



Figure 25: CHANNEL CONFIGURATION Control Flow Diagram

- a. For a dual-channel system, first select the desired channel for which to conduct the procedure. The number of any chosen active channel will be indicated in the upper-left corner of the display for the remainder of this submenu.
- b. Depending on the System Mode configuration, the option to restore the Factory settings from non-volatile Flash memory for use as the system settings is presented. Given the system impact of this option, the user is first asked to confirm their selection to access the menu via an “RU Sure?” prompt, for “Are You Sure?” A “Yes” response will continue; a “No” response will skip the option. The Factory Restore operation is intended to read back all of the channel-specific, calibration and configuration data previously saved to protected Flash memory via a Factory Save operation. If a Factory Save operation was not previously performed on the selected channel, the Factory Restore operation will be terminated and a temporary error message will be displayed. In addition,

		<b>AccuPro-5000™ MEASUREMENT SYSTEM OPERATOR MANUAL</b>	
Issued by Department: Engineering	Doc. Number: 5000-00-00-002	Revision: 02	Effective Date: 10/05/2021

whenever the Factory Restore operation is terminated for an Analog Input Board (AIB), so will the restore operation for any Analog Output Board (AOB) present for the respective channel.

- c. Select and enter the desired units for scale measurement. Units of Pound (lb), Kilogram (kg), Gallon (gal), and Liter (ltr) are supported.
- d. Select and enter the desired measurement precision by choosing to include either 0 or 1 decimal places in the displayed value.
- e. Scale measurement values are the result of a moving-average calculation on randomly-sampled data. The user is able to select and enter the desired number of data samples used to compute an averaged measurement value depending on the desired amount of smoothing, or data filtering. Available options include 10, 20, 50, or 100 samples/moving-average. If the material being measured is a sloshing liquid, then an increased number of samples-per-average may be desirable to stabilize the measured value. Note that as the number of samples-per-average is increased, the measurement update rate is proportionally reduced. Finally, if the system detects a large, instantaneous measurement change of 50% or more, it will reset the moving-average data buffers to yield a shorter settling time. These events are typical whenever material is either added or removed from the scale base in a quick manner.
- f. Select and enter whether the Scale Display menu should include a proportional bar-graph that reflects components of the measurement value. The bar-graph will be displayed on the bottom line of the LCD below the scale's averaged, measured numerical value. The full-scale of the bar-graph area depicts the channel's Capacity Weight. The cross-hatched region depicts the measured component attributed to Tare Weight, while the solid region depicts the averaged measured Net Weight as illustrated in Figure 26.

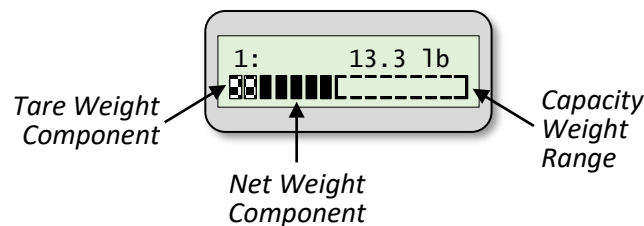

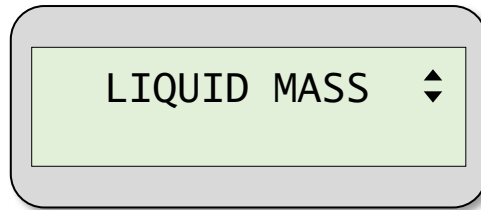

Figure 26: Bar-Graph Display

## 8.8 Liquid Mass

Select this menu option by pressing the Enter Key while the display appears as shown in Figure 27.

	<b>AccuPro-5000™ MEASUREMENT SYSTEM OPERATOR MANUAL</b>		
Issued by Department: Engineering	Doc. Number: 5000-00-00-002	Revision: 02	Effective Date: 10/05/2021



*Figure 27: LIQUID MASS Menu Option*

This menu supports scale measurement in volumetric units; thus, it is only made available if an active channel is configured to display its averaged measurement in units of volume; either gallons or liters.

### 8.8.1 Procedure

The procedure for navigating the Liquid Mass submenu follows the control flow diagram depicted in Figure 28.

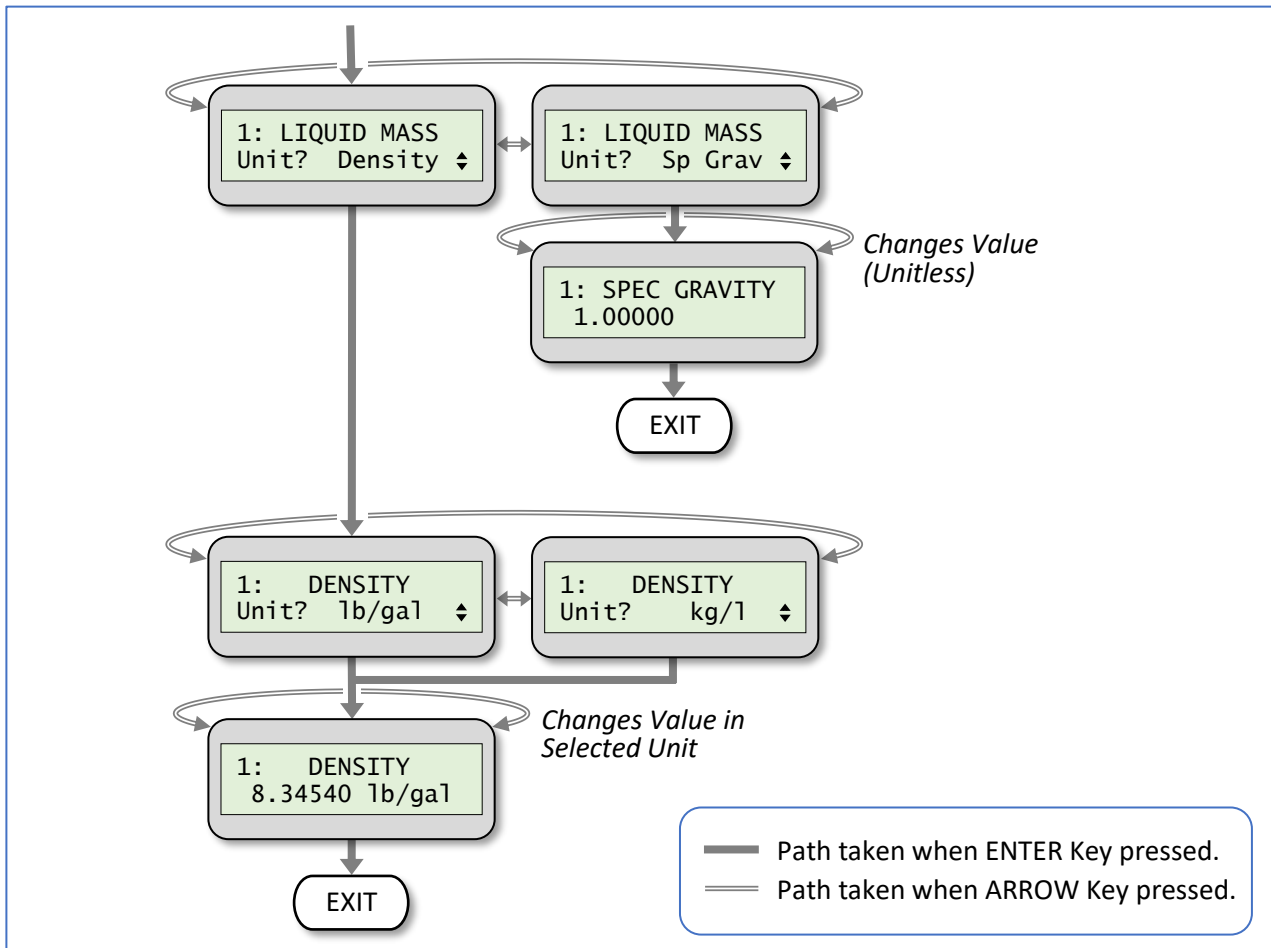

Figure 28: LIQUID MASS Control Flow Diagram

- For a dual-channel system, first select the desired channel for which to conduct the procedure. The number of any chosen active channel will be indicated in the upper-left corner of the display for the remainder of this submenu.
- Select whether the Liquid Mass value to be entered represents a known density (weight/volume) or specific gravity (unitless) value. If this submenu is being entered for the first time, or if a change in the unit is detected, the default Liquid Mass value will be that of pure water, whether it be represented as a density (8.34540 lb/gal) or specific gravity (1.00000).
- If a Liquid Mass density is to be entered, select whether the density units are pounds/gallon (lb/gal) or kilograms/liter (kg/l).
- Enter a Liquid Mass value as selected representing either a density or specific gravity.

## 8.9 Tare Adjust / Tare Secured

Select this menu option by pressing the Enter Key while the display appears as shown in Figure 29.



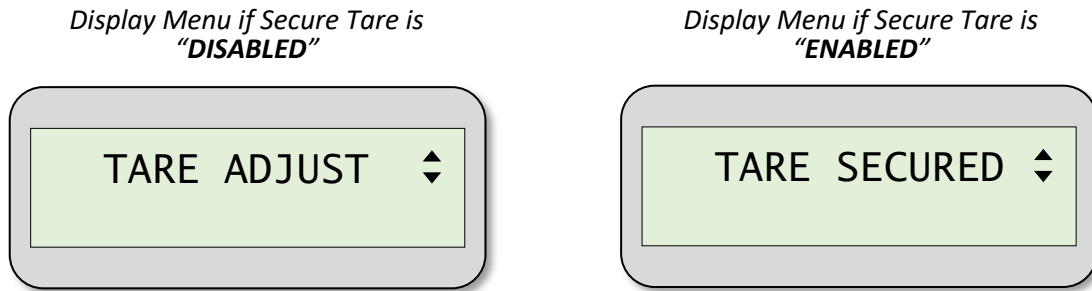

Figure 29: TARE ADJUST & TARE SECURED Menu Option

This menu provides a means to “zero-out” any component of weight or volume attributed to the container used to hold a chemical substance whose net weight or net volume is to be measured. It represents a negative offset value which, when added to the gross measurement, allows a net value to be displayed. One of two methods can be used to adjust for tare. First, with nothing on the scale, the user can enter a known tare value in selectable weight or volume units. Second, with an empty container of unknown weight placed on the scale, the user can adjust the tare value until the net measurement display reads zero.

### 8.9.1 Procedure

The procedures for navigating the TARE ADJUST and TARE SECURED submenus follow the control flow diagrams as depicted in Figure 30 and Figure 31, respectively.

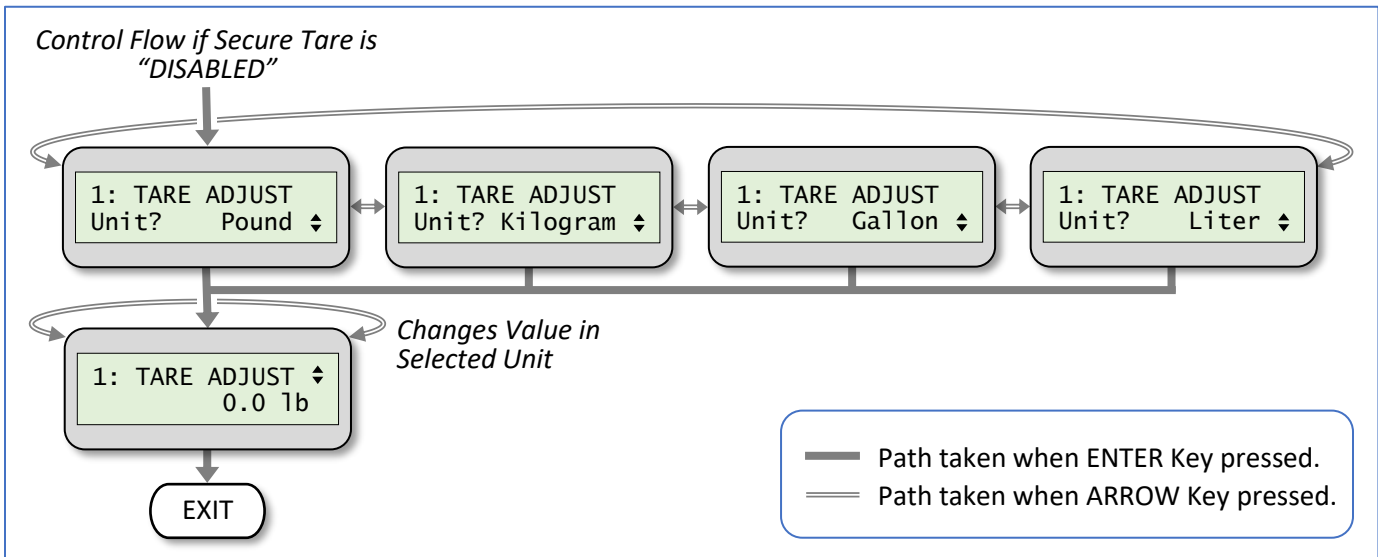



Figure 30: TARE ADJUST Control Flow Diagram

		<b>AccuPro-5000™ MEASUREMENT SYSTEM OPERATOR MANUAL</b>	
Issued by Department: <b>Engineering</b>	Doc. Number: 5000-00-00-002	Revision: 02	Effective Date: 10/05/2021

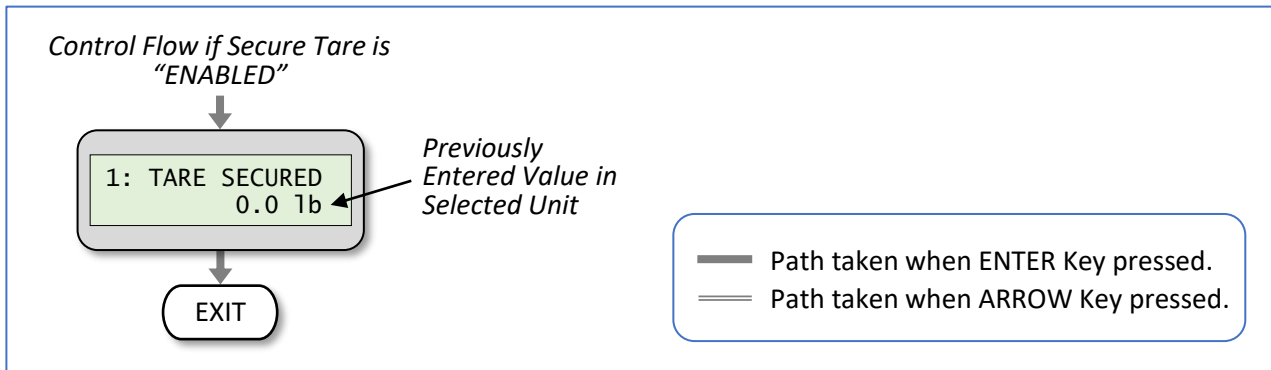



Figure 31: TARE SECURED Control Flow Diagram

- Access to this menu requires that channel calibration procedures be completed. User is prompted via the display to first enter any missing required parameters.
- If the system is in Run Mode with Tare Secure enabled (see *System Config* menu), the menu title will appear as “Tare Secured”, otherwise, it will read “Tare Adjust.”
- For a dual-channel system, first select the desired channel for which to conduct the procedure. The number of any chosen active channel will be indicated in the upper-left corner of the display for the remainder of this submenu.
- If the system is in RUN Mode with Secure Tare enabled (See *System Config* menu), the user will not be able to make adjustments to the current tare value. Instead, the display will indicate the current tare value.
- Select and enter the desired tare units. Units of Pound (lb), Kilogram (kg), Gallon (gal), and Liter (ltr) are supported. If a unit change is detected, the default tare value is reset to zero. Otherwise, the starting tare value is set to the previously entered value. Note that the selected tare units do not have to match the selected scale measurement units.
- Enter a Tare value in the previously-selected units using one of the two methods previously described. The maximum Tare value is 0 (no Tare) and the minimum value is the negative equivalent of the previously entered Capacity Weight converted into the selected units of tare. An arrow symbol is appended at the end of the top row of the display to indicate the available range of the tare adjustment. For example, a Down-Arrow indicates the tare value is currently at its maximum, or zero, meaning only a decrease in value is possible. Similarly, an Up-Arrow indicates the current value is at its minimum, meaning only an increase in value is possible. An Up/Down-Arrow indicates the current value can be increased or decreased.

## 8.10 Relay Setpoint

Select this menu option by pressing the Enter Key while the display appears as shown in Figure 32.

	<b>AccuPro-5000™ MEASUREMENT SYSTEM OPERATOR MANUAL</b>		
Issued by Department: Engineering	Doc. Number: 5000-00-00-002	Revision: 02	Effective Date: 10/05/2021

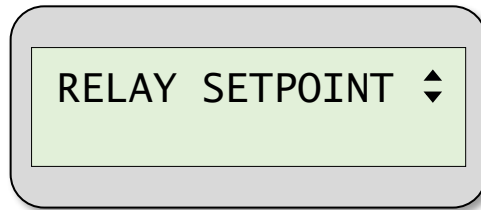

*Figure 32: RELAY SETPOINT Menu Option*

This menu provides a means to configure either 2 (Dual Relay Output Board) or 4 (Quad Relay Output Board) relay setpoints. The user is able to define an independent trigger measurement and set of behavior criteria for each relay port.

### **8.10.1 Procedure**

The procedure for navigating the Relay Setpoint submenu follows the control flow diagram depicted in Figure 33.

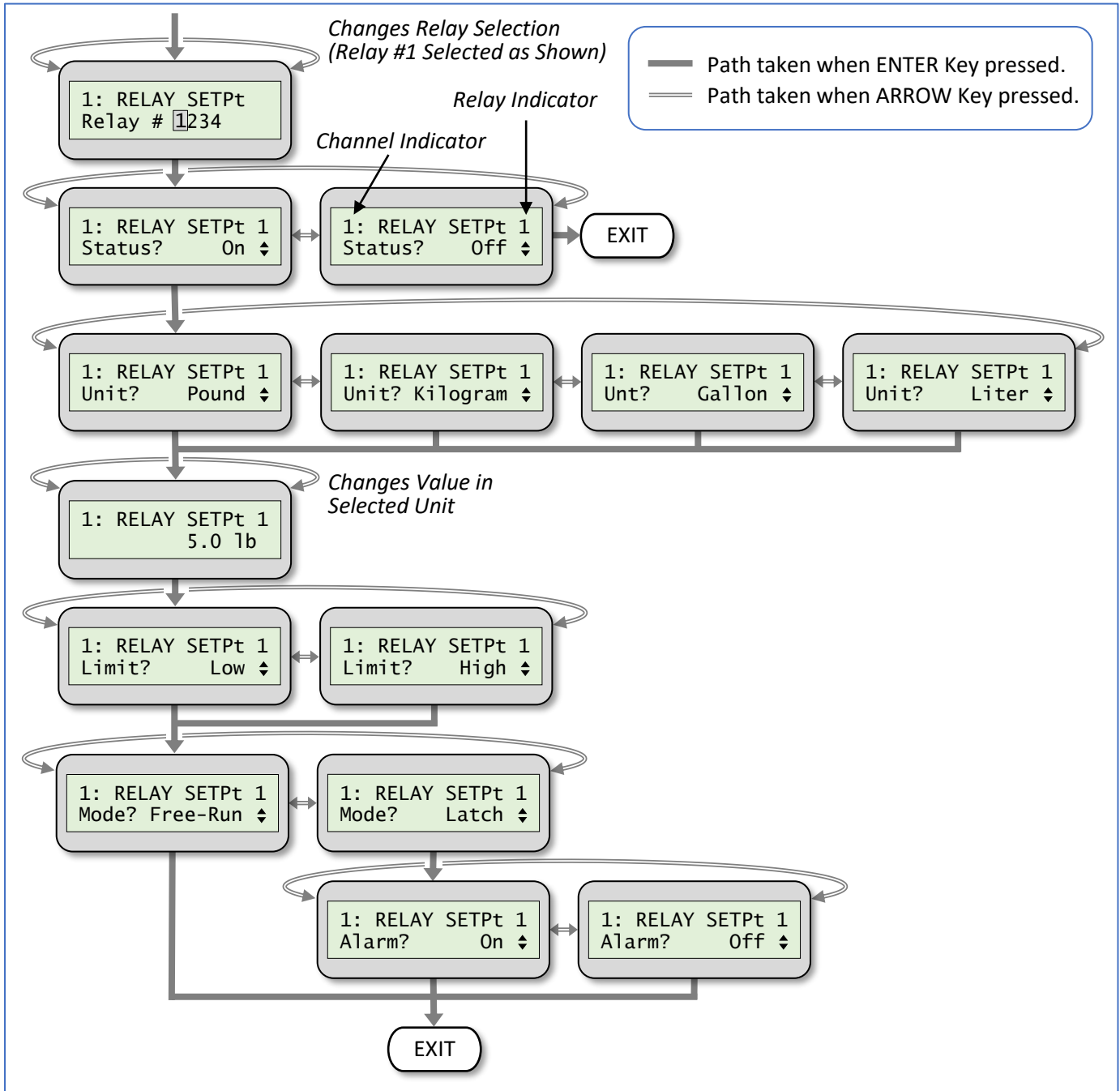



Figure 33: RELAY SETPOINT Control Flow Diagram

- This menu is only available when the system detects an active channel configured with either a Dual or Quad Relay Output Board.
- Access to this menu requires that channel calibration procedures be completed. User is prompted via a display message (Not shown on Control-Flow diagram) to first enter any missing required parameters.

		<b>AccuPro-5000™ MEASUREMENT SYSTEM OPERATOR MANUAL</b>	
Issued by Department: Engineering	Doc. Number: 5000-00-00-002	Revision: 02	Effective Date: 10/05/2021

- c. For a dual-channel system, first select the desired channel for which to conduct the procedure. The number of any chosen active channel will be indicated in the upper-left corner of the display for the remainder of this submenu.
- d. Select and enter a specific relay number indexed as 1 through 2 for a Dual Relay Output Board, or 1 through 4 for a Quad Relay Output Board. The number of the chosen relay will be indicated in the upper-right corner of the display for the remainder of this submenu.
- e. Select whether or not the desired status of the selected relay is ON (enabled) or OFF (disabled). If the respective relay is energized at the moment its status changes from ON to OFF, it will be de-energized. A disabled relay will remain de-energized regardless of the respective scale-measurement.
- f. If the selected relay status is OFF, the remaining configuration options are skipped and the menu is exited. Otherwise, if the selected relay status is ON, the procedure will continue.
- g. Select and enter the desired scale-measurement Setpoint units. Units of Pound (lb), Kilogram (kg), Gallon (gal), and Liter (ltr) are supported.
- h. Enter the Setpoint value (i.e. gross minus tare) in the previously-selected units. The minimum value is 0 and the maximum value corresponds to the previously entered Capacity Weight.
- i. Select and enter whether the Setpoint value represents either a Low or High Limit. A Low Limit will cause the selected relay to become energized when the respective scale's averaged measurement value falls below the previously entered Setpoint value. Likewise, a High Limit will cause the selected relay to become energized when the respective scale's averaged measurement value lies above the previously entered Setpoint value.
- j. Select and enter the desired Setpoint Mode to either Free-Run or Latch. In Free-Run Mode, once a relay becomes energized, it will remain energized only as long as the trigger condition is maintained. That is, the state of the relay tracks the trigger condition in real-time. Conversely, when a relay configured in Latch Mode is energized by the defined trigger condition, it will remain energized even if the trigger condition is no longer satisfied. The user must first acknowledge the event within the Alert & Alarm menu previously described to reset the latched state of any relay.
- k. If Latch Mode was previously selected, select whether or not a triggered Setpoint should assert the audible alarm.

## 8.11 mA/V Output

Select this menu option by pressing the Enter Key while the display appears as shown in Figure 34.

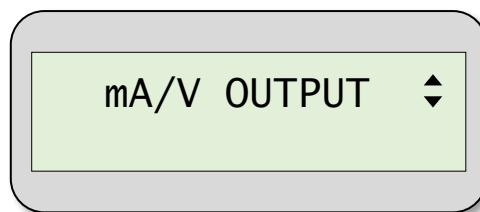

Figure 34: mA/V OUTPUT Menu Option

This menu provides a means to calibrate the DAC values for the lower (4 mA) and upper (20 mA) loop limits. It also supports assigning scale-measurement Setpoints for each of the loop limits. Given the

procedure attempts to validate entered values, a fully-calibrated AIB is required for the respective channel.

Entered values will be used to generate an analog output that is linearly proportional to the real-time scale measurement following a straight-line approximation between the two entered Setpoints. In the case of a current-loop output, if the net scale measurement falls outside the range of the Setpoints, the loop output will be clipped at 3.5mA on the low end and 20.5mA on the high end, yielding a 0.5mA margin.

### 8.11.1 Procedure

The procedure for navigating the mA/V Output submenu follows the control flow diagram depicted in Figure 35.

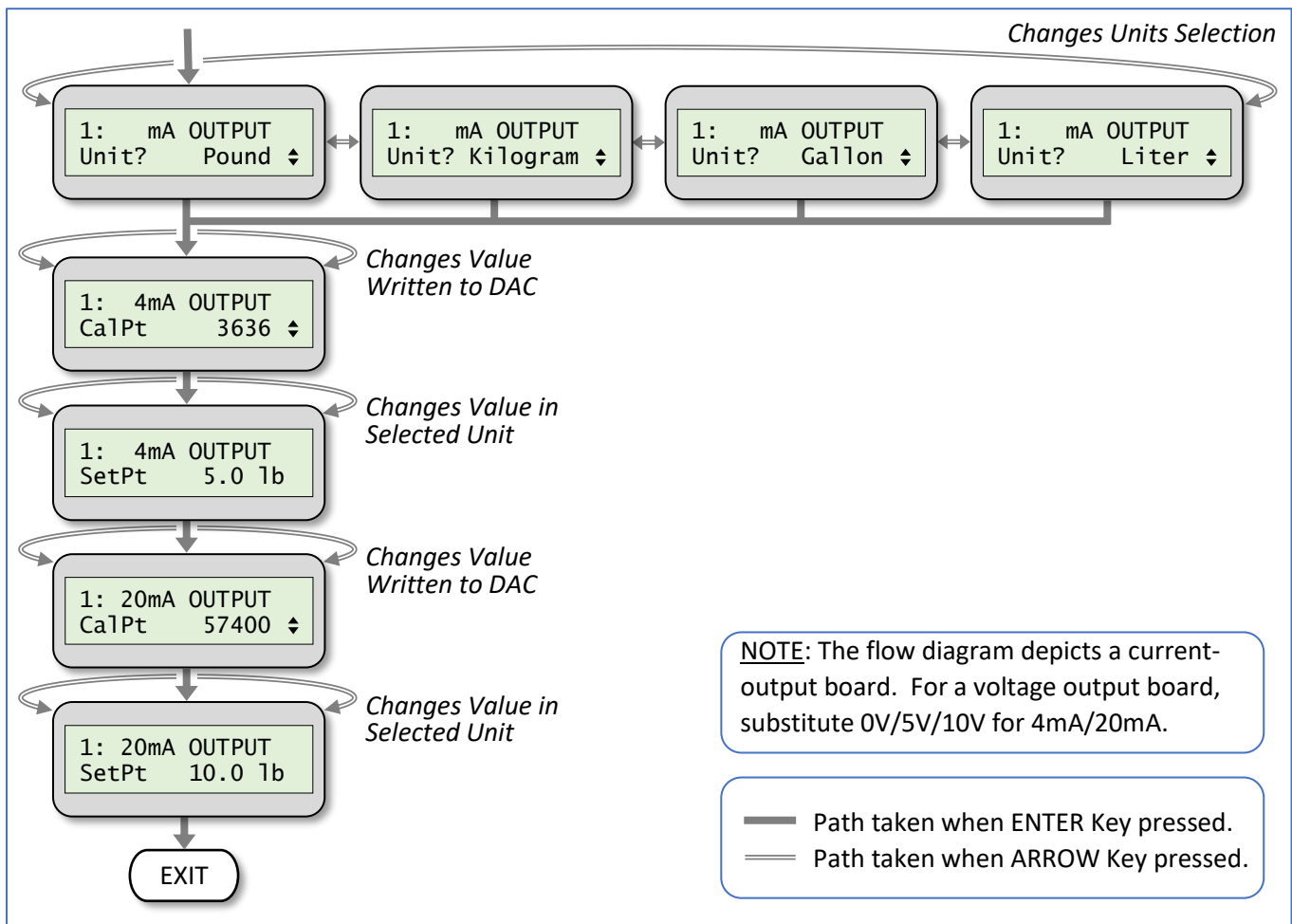

Figure 35: mA/V OUTPUT Control Flow Diagram

- This menu option is only available if an active channel is configured with an Analog Output Board (mA or V). Option selections are saved to non-volatile memory located on the Analog Output Board.



## AccuPro-5000™ MEASUREMENT SYSTEM OPERATOR MANUAL

Issued by Department: Engineering	Doc. Number: 5000-00-00-002	Revision: 02	Effective Date: 10/05/2021
--------------------------------------	--------------------------------	-----------------	-------------------------------

- b. Access to this menu requires that Analog Input Board calibration procedures be completed at the factory for the respective channel. If calibration is not complete, a display message is presented to first enter any missing required parameters.
- c. For a dual-channel system, first select the desired channel for which to conduct the procedure. The number of any chosen active channel will be indicated in the upper-left corner of the display for the remainder of this submenu.
- d. The user is prompted to select and enter the desired units for the limit Setpoints. If Setpoints were previously entered, then those units will be presented as the default units. Units of Pound (lb), Kilogram (kg), Gallon (gal), and Liter (ltr) are supported.
- e. If Factory Setup Mode is asserted, the decimal (unsigned integer) representation of the 16-bit DAC calibration value [Range: 0 to 65,534] for calibrating the minimum output will be displayed.
  - **AOB-mA board:** Adjust the DAC calibration value to yield a measured 4 mA loop output at the output terminal block, or 2-pin header (P2), using a digital meter (three decimal places.) If the current-loop is to be internally powered by the scale, be sure to position the board's *Loop Power Slider-Switch* to SCALE, which is when the text "SCALE" is visible beneath the slider.
  - **AOB-V board:** Adjust the DAC calibration value to yield a measured 0 V output at the output terminal block, or 2-pin header (P4), using a digital meter (three decimal places.) Be sure to first select the voltage output range via the 2-pin jumper field.
- f. Enter the 4 mA (or 0 V) scale-measurement Setpoint in the previously-selected units. Any previously entered Setpoint will be presented as the default value, unless a change of units was detected in a previous step, in which case the Setpoint value will be reset to zero. The value is always positive in the range from zero through (Capacity Weight – 1). The number of decimal points of the displayed value represents the user-selection previously made in the *Channel Config* menu option.
- g. If Factory Setup Mode is asserted, the decimal (unsigned integer) representation of the 16-bit DAC calibration value [Range: (minimum output DAC calibration value + 1) to 65,535] for calibrating the maximum output will be displayed.
  - **AOB-mA board:** Adjust the DAC calibration value to yield a measured 20 mA loop output at the output terminal block, or 2-pin header (P2), using a digital meter (three decimal places.) If the current-loop is internally energized, be sure to position the board's *Loop Power Slider-Switch* to SCALE, which is when the text "SCALE" is visible beneath the slider.
  - **AOB-V board:** Adjust the DAC calibration value to yield a measured 5V/10V output at the output terminal block, or 2-pin header (P4), using a digital meter (three decimal places.) Be sure to first select the voltage output range via the 2-pin jumper field.
- h. Enter the 20 mA (or 5V/10V) scale-measurement Setpoint in the previously-selected units. Any previously entered Setpoint will be presented as the default value, unless a change of units was detected in a previous step, in which case the Setpoint value will be reset to zero. The value is always positive in the range from (minimum Setpoint + 1) to the previously-entered Capacity Weight. In this manner, the maximum Setpoint is forced to be greater than the minimum Setpoint. The number of decimal points of the displayed value represents the user-selection previously made in the *Channel Config* menu option.

### 8.12 Real-Time Clock

Select this menu option by pressing the Enter Key while the display appears as shown in Figure 36.

		<b>AccuPro-5000™ MEASUREMENT SYSTEM OPERATOR MANUAL</b>	
Issued by Department: <b>Engineering</b>	Doc. Number: 5000-00-00-002	Revision: 02	Effective Date: 10/05/2021

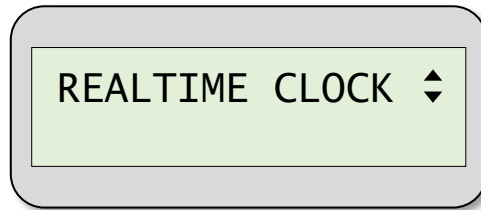

*Figure 36: REALTIME CLOCK Menu Option*

The system includes a Real-Time Clock (RTC) intended for tagging logged events with a time-stamp. Select the menu by pressing the Enter Key which will cause the current time to be displayed in the format HH:MM:SSxm, where “xm” is either “am” or “pm.” The date is also tracked and displayed in the format MM/DD/YY.

### **8.12.1 Procedure for Setting the Time/Date**

The procedure for navigating the Realtime Clock submenu follows the control flow diagram depicted in Figure 37.



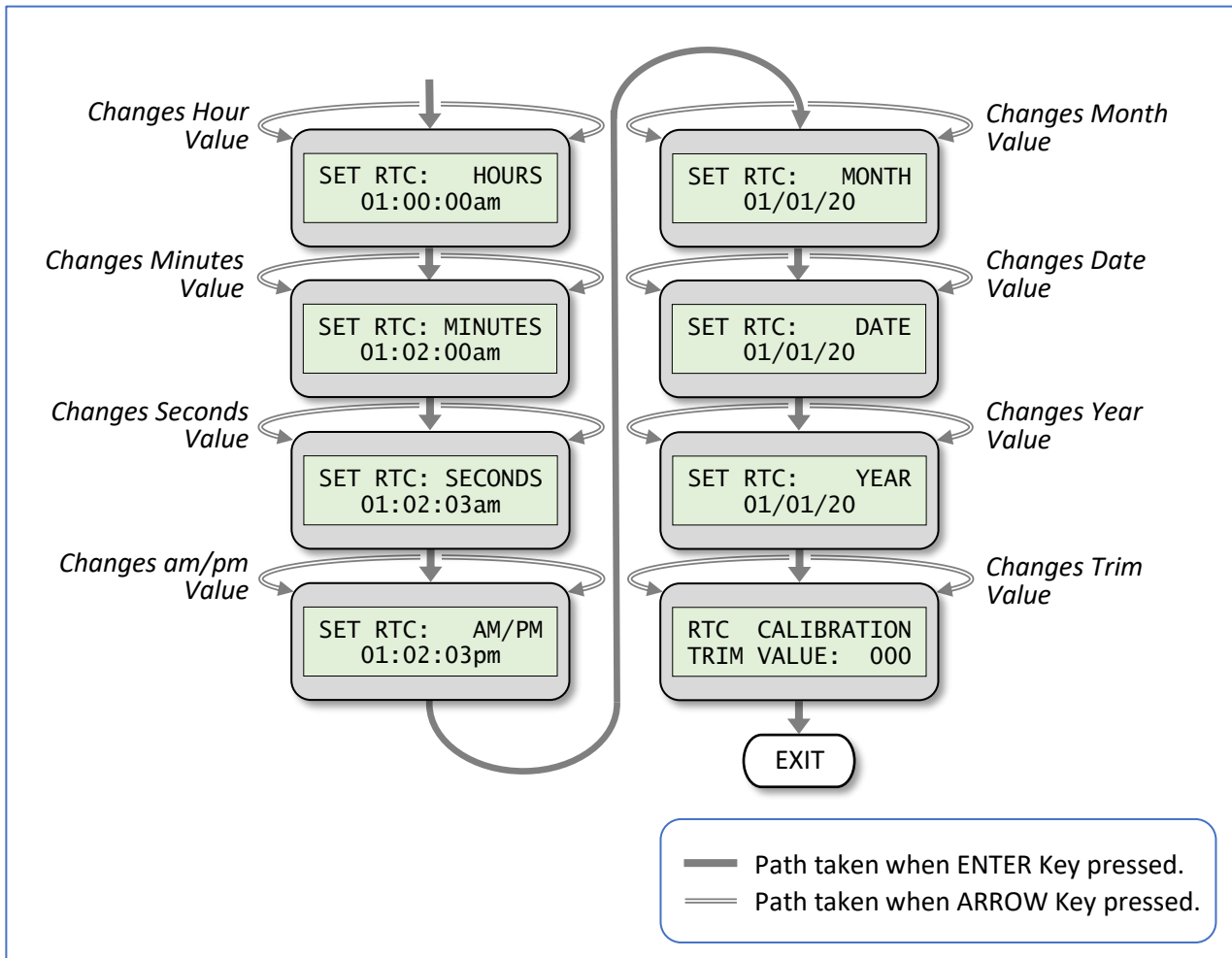



Figure 37: Setting the Time/Date Control Flow Diagram

- **Set RTC Hours:** Use the controls to modify the hours field, then press ENTER to make the selection. Numbers range from 01 through 12.
- **Set RTC Minutes:** Use the controls to modify the minutes field, then press ENTER to make the selection. Numbers range from 00 through 59.
- **Set RTC Seconds:** Use the controls to modify the seconds field, then press ENTER to make the selection. Numbers range from 00 through 59.
- **Set RTC am/pm:** Use the controls to modify the meridiem field, then press ENTER to make the selection. Available options are “am” for ante-meridiem, or “pm” for post-meridiem. It’s important to note that the clock oscillator and battery-backup will be enabled at the moment this entry is selected. This allows the user to synchronize the start of the RTC with an external time reference. It is typical to enter a future time about 10 seconds ahead of actual time, then wait until the actual time catches up to press the Enter key. Immediately following selection, a check of the RTC oscillator status is performed. A temporary error message (Not shown on Control-Flow diagram) is displayed if oscillator activity is not detected.

		<b>AccuPro-5000™ MEASUREMENT SYSTEM OPERATOR MANUAL</b>	
Issued by Department: Engineering	Doc. Number: 5000-00-00-002	Revision: 02	Effective Date: 10/05/2021

- **Set RTC Month:** Use the controls to modify the months field, then press ENTER to make the selection. Numbers range from 01 through 12 for January through December, respectively.
- **Set RTC Date:** Use the controls to modify the date field, then press ENTER to make the selection. Numbers range from 01 through 31.
- **Set RTC Year:** Use the controls to modify the year field, then press ENTER to make the selection. Numbers range from 01 through 99.
- **Set RTC Trim:** A Trim value is used to calibrate the oscillator to improve its accuracy. It represents a signed oscillator correction which is added once every minute. Calibration is performed by measuring the averaged oscillator output frequency at Test Point TP32 (CLKOUT) which is configured to be 4.096 kHz. The Trim value to be entered is computed as:

$$((F_{\text{ideal}} - F_{\text{measured}}) \times (32768 / F_{\text{ideal}}) \times 60) / 2$$

- Use the controls to modify the signed value, then press ENTER to make the selection. Numbers range from -255 through +255.

## 8.13 About

Select this menu option by pressing the Enter Key while the display appears as shown in Figure 38.



*Figure 38: ABOUT Menu Option*

This menu offers a means to present configuration and version control information. Use the controls to rotate through the various information displays. Pressing the Enter Key at any time will return control to the main menu.

### 8.13.1 Procedure

The procedure for navigating the ABOUT submenu follows the control flow diagram depicted in Figure 39.

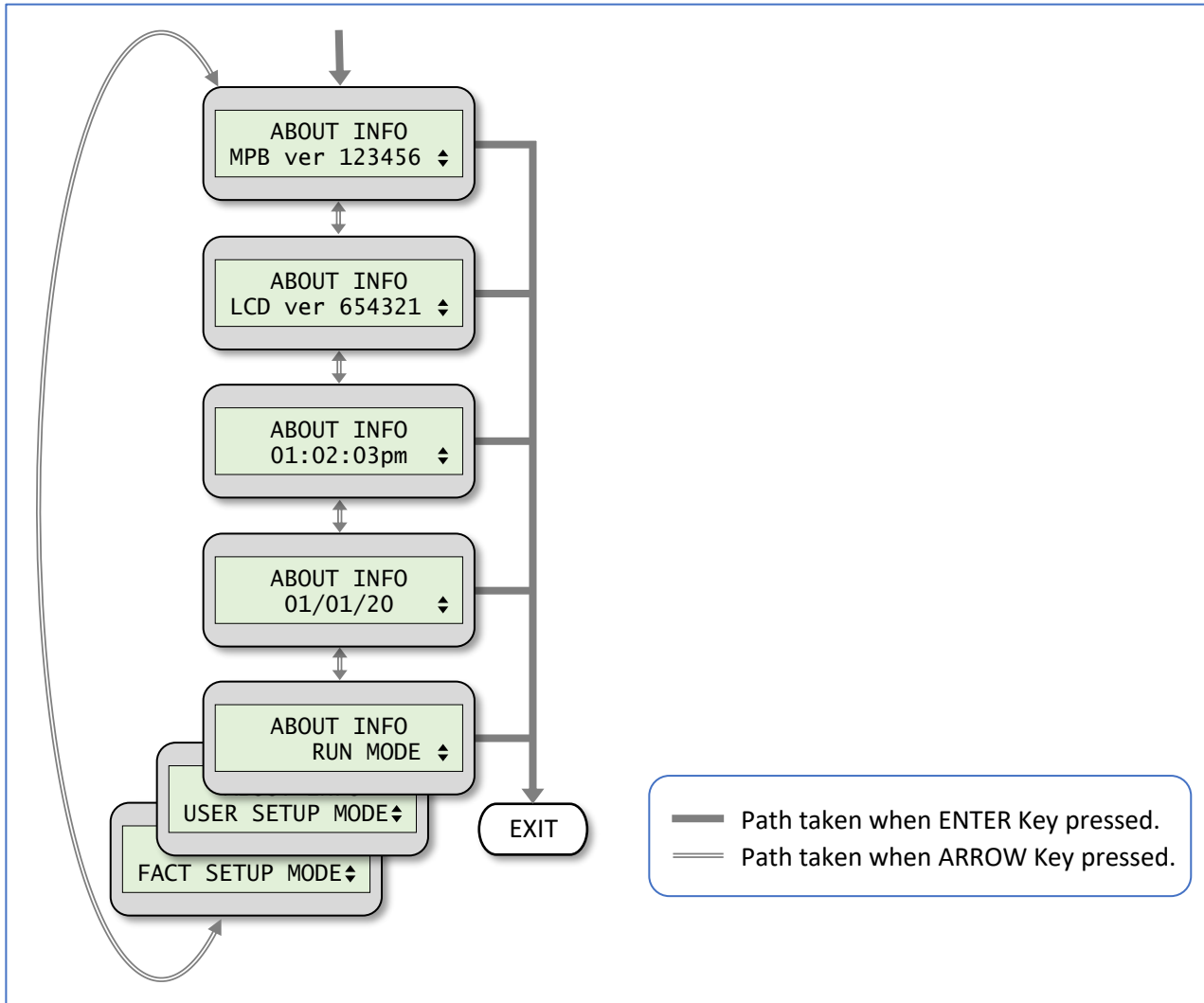



Figure 39: ABOUT Control Flow Diagram

- **Main Processor Board SW Version #:** Displays the software version number of the Main Processor Board’s code.
- **LCD Board SW Version #:** Displays the software version number of the LCD Board’s code. A version field represented with “?????” indicates that the attempt to query the LCD Board’s processor had either failed or not taken place.
- **Current Time:** Displays the current time of the Real-Time Clock. The time should be actively incrementing, else the RTC oscillator is not running.
- **Current Date:** Displays the current date of the Real-Time Clock.
- **System Mode:** Displays the real-time System Mode as defined by the Mode Slider-Switch and Setup jumper-field. Possible states include Run Mode, User Setup Mode, and Factory Setup Mode.

		<b>AccuPro-5000™ MEASUREMENT SYSTEM OPERATOR MANUAL</b>	
Issued by Department: Engineering	Doc. Number: 5000-00-00-002	Revision: 02	Effective Date: 10/05/2021

## 9 Maintenance

**IMPORTANT:** *All electronics within the Control-Panel are sensitive to static discharge. Precautions MUST be taken to eliminate static discharge whenever accessing electronics else permanent damage may result. DO NOT...*

- *...attempt to access internal circuitry without taking proper anti-static precautions.*
- *...make or remove wiring connections with power turned ON.*
- *...remove any printed circuit boards with power turned ON.*

### 9.1 Cleaning

If the Control-Panel should require cleaning, first determine which cleaning products are safe to use in your specific chemical environment and conditions. It is generally recommended that a cloth dampened with water be used to wipe the display and keypad areas. However, you must use your own discretion when cleaning with any substances. Harsh or abrasive cleaners are NOT recommended as they may etch or scratch the finish on the mylar keypad or enclosure. Mild cleaners are generally safe to use.

Care should be taken to keep material and chemical spills off the Scale-Base as it may cause an inaccurate measurement reading.

### 9.2 Servicing the Control-Panel

It is sometimes necessary to access the interior circuitry of the Control-Panel. Such is the case during installation of system wiring and general maintenance. Be sure to follow recommendations as to whether main power should be turned off during a given procedure.

The Control-Panel door is secured shut by a latch and four screws (optional) located on the four corners of the door. Carefully remove the screws and open the latch to gain access to the internal circuitry and connectors.

### 9.3 Removing/Installing a Printed Circuit Board

It is imperative that power be OFF during the removal or installation of a printed circuit board within the Control-Panel. All removeable boards are secured in their sockets via two push-pins located in the upper region of their respective card-guides. To remove a PCB, use a finger or flat screw-driver to gently push on each silver, metal tab until they bottom out against the card-guide. It may be helpful to provide support on the opposite side of the card-guide while pushing to prevent flexing of the PCB. Either grab the top edge of the PCB with your fingers, or use a tool to hook through the access hole located near the top-center of the board, then gently pull straight up along the axis of the card-guides.

To install a PCB, confirm the target slot and board alignment before gently pushing straight down in the center of the board's top edge. A mild snap may be felt as the board-edge connector mates with that of

		<b>AccuPro-5000™ MEASUREMENT SYSTEM OPERATOR MANUAL</b>	
Issued by Department: Engineering	Doc. Number: 5000-00-00-002	Revision: 02	Effective Date: 10/05/2021

the Backplane Board. Secure the PCB via two push-pins located in the upper region of the respective card-guides. Use a finger or flat screw-driver to gently push on each red, plastic tab until they bottom out against the card-guide. Do not use excessive force as it may indicate that the PCB is not completely seated in its mating connector.

## 9.4 Removing/Installing PCB Wire Connections

It is imperative that power be OFF during the removal or installation of wire connections to a printed circuit board within the Control-Panel. It is further advised that the PCB be temporarily removed from its slot by following the procedure described in section titled *Removing/Installing a Printed Circuit Board*. This will ease the operation of the connector’s spring-loaded mechanism.

All PCB connectors are able to support wire connections in the range of 16-26 AWG. Each wire must have approximately 0.35 inches (9 mm) of insulation removed from its tip. To insert a wire, carefully pinch the bottom of the PCB and the spring-loaded button of the respective contact position to open the contacts. While holding the button pressed, insert the wire into the contact opening and maintain insertion while slowly releasing the button. Gently tug on the wire to verify proper connection. To remove a wire connection, gently tug on the wire while pinching the spring-loaded button as previously described.

## 10 Troubleshooting

**IMPORTANT: DO NOT ATTEMPT TO ALTER OR RE-CALIBRATE THIS INSTRUMENT UNLESS INSTRUCTED TO DO SO. IT HAS BEEN FACTORY CALIBRATED AND TESTED BEFORE BEING SHIPPED.**

When experiencing unexpected behavior, please read the following scenarios for easy self-diagnosis and correction before calling the factory for assistance. If problems persist, please call the factory. In the U.S.A. call (800) 257-5911. Outside the U.S.A. call (215) 766-2670.

### 10.1 The Control-Panel is Not Receiving Power

**WARNING: DO NOT, AT ANY TIME, STICK ANYTHING INTO THE OPEN FRAME POWER SUPPLY OR TOUCH ITS COMPONENTS ELSE SERIOUS SHOCK INJURIES MAY OCCUR !**

Confirm that the Control-Panel is plugged into an AC outlet providing the proper voltage. Next, with main power removed, carefully open the Control-Panel by following the procedure as outlined in section titled *Servicing the Control-Panel*. Remove and inspect the power supply fuse mounted on the metal bracket. Replace any blown fuse with one having the same specifications and then re-evaluate. If the fuse is good, carefully restore main power and check to see if any of the PCB LEDs are lit, particularly the “heartbeat” LED on the back of the LCD Board. The LCD Board receives its power via the ribbon

		<b>AccuPro-5000™ MEASUREMENT SYSTEM OPERATOR MANUAL</b>	
Issued by Department: Engineering	Doc. Number: 5000-00-00-002	Revision: 02	Effective Date: 10/05/2021

cable, thus it's possible that only that PCB is lacking power. If no LEDs are lit on the LCD Board but are lit elsewhere, then the problem may be with the ribbon cable. If no LEDs are lit on any PCB, then further inspection is needed.

The system power supply and other sources of power from the AccuPro-5000™, such as load-cell excitation voltages and the 4-20 mA current loops, are protected with independent current-limiting features. The best approach to isolating a power problem would be to remove main power to the system, then unplugging all of the PCBs except for the Main Processor Board. Restore main power and then re-evaluate. If any LED activity is observed, remove main power once again and repeat the test after inserting another PCB, one at a time, beginning with the AIBs, then AOBs, then finally the ROBs. If the insertion of any PCB causes loss of normal LED activity, then closely examine that PCB for faulty external wiring. Consult the factory if the problem persists.

## 10.2 The Measurement Value is Blinking

Whenever the measurement value (Tare + Net) exceeds the predefined capacity limit as configured by the factory, the measurement value will blink. Though the system will continue to resolve and display a measurement value under these conditions, the accuracy of the measurement must be questioned. The immediate solution is to reduce the load on the Scale-Base until the blinking stops. Call the factory for options of a long-term solution.

## 10.3 The 4-to-20 mA Reading is Incorrect

Confirm that the current output is properly configured within the *mA/V Output* menu. Pay particular attention to the selection of units and setpoint options. Next, with power OFF, open the Control-Panel by following the procedure as outlined in section titled *Servicing the Control-Panel*. The 4-to-20 mA circuit must be powered with a voltage supply. Confirm proper position of the slider-switch on the circuit board that selects the power source as being internally-supplied (the text "SCALE" is visible below the slider) or externally-supplied (the text "LOOP" is visible below the slider).

**WARNING: DO NOT CONFIGURE POWER SLIDER-SWITCH FOR INTERNAL "SCALE" SUPPLY IF AN EXTERNAL "LOOP" SUPPLY IS ALSO PRESENT. PERMANENT DAMAGE TO THIS CIRCUIT AND/OR EXTERNAL CIRCUITRY MAY OCCUR !**

If an external supply is being used, measure the voltage at the connector and confirm it's within the expected range. Note that the voltage level must be high enough to source 20 mA across the total loop resistance. Check that the wires to the loop connector are in the proper contact position. The positions are clearly marked on the PCB as current source (+) and current return (-). Confirm that sufficient insulation was removed from the loop wires to prevent the spring-loaded connector contacts from pinching the insulation rather than the wire itself. The wires should stay in the connector even when **gently** tugged. If the problem persists, take note of the loop current behavior under a changing scale load and call the factory for assistance.



## AccuPro-5000™ MEASUREMENT SYSTEM OPERATOR MANUAL

Issued by Department: Engineering	Doc. Number: 5000-00-00-002	Revision: 02	Effective Date: 10/05/2021
--------------------------------------	--------------------------------	-----------------	-------------------------------

### 10.4 A Relay Output is Not Responding Correctly

Confirm that the relay is properly configured within the *Relay Setpoint* menu. Pay particular attention to the selection of units, setpoints, limits, and mode options. Next, with power OFF, open the Control-Panel by following the procedure as outlined in section titled *Servicing the Control-Panel*. Check that the wires to the respective relay connector are in the proper contact position. The positions are clearly marked on the PCB as Normally-Open (NO), Common (COM), and Normally-Closed (NC). Confirm that sufficient insulation was removed from the wires to prevent the spring-loaded connector contacts from pinching the insulation rather than the wire itself. The wires should stay in the connector even when **gently** tugged. Lastly, restore power to the Control-Panel and create the conditions that should cause the relay to energize. Confirm whether or not the respective relay is being energized by the state of its status LED. The LED should be ON whenever the relay is energized. If the problem persists, please call the factory for further assistance.

### 10.5 Tare Weight Drift

It is common for accidental chemical spillage to accumulate on the Scale-Base leading to an unexpected offset in the tare weight setting. Some Scale-Bases are equipped with an optional sensor designed to detect liquid spills. Be sure to remove any build-up of dry chemicals or residue of liquid chemicals that may otherwise taint a net measurement reading.



# AccuPro-5000™ MEASUREMENT SYSTEM OPERATOR MANUAL

Issued by Department:  
Engineering

Doc. Number:  
5000-00-00-002

Revision:  
02

Effective Date:  
10/05/2021

## 11 Revision Log

Rev	Page(s)	Description	Date	Name
01	All	Create Document	08/05/2021	Mark Z
02	1, 4, 5, 8, 31, 27, 34	<ul style="list-style-type: none"><li>Updated company mailing address.</li><li>Added list of Figures and Tables.</li><li>Relocated Wattage and Fuse specifications to Main Power section.</li><li>Corrected reference to Note (2) in Operation Menu Tree table.</li><li>Added Flash Error notifications in Alerts/Alarms section.</li></ul>	10/05/2021	Mark Z